



Installation Instructions

For Part Numbers:

300-190	700-445 Airaid Oiled Media Filter
301-190	701-445 SynthaMax Dry Media Filter - Red
302-190	702-445 SynthaMax Dry Media Filter - Black
303-190	703-445 SynthaMax Dry Media Filter - Blue

2006-08 Dodge Ram 1500/2500/3500
5.7L V8

Component Identification

1.	Airaid Premium Filter	1
2.	Quick Fit Panel	1
3.	Modular Intake Tube	1
4.	Urethane Hump Hose	1
5.	Reducing Coupler	1
6.	Weather Strip 32 3/4"	1
7.	Black Rubber Cap	1
8.	#52 Hose Clamp	2
9.	#60 Hose Clamp	2
10.	#14 Speed Clamp	1
11.	#24 Speed Clamp	1
12.	Rubber Grommet	1
13.	Airaid Decal	1

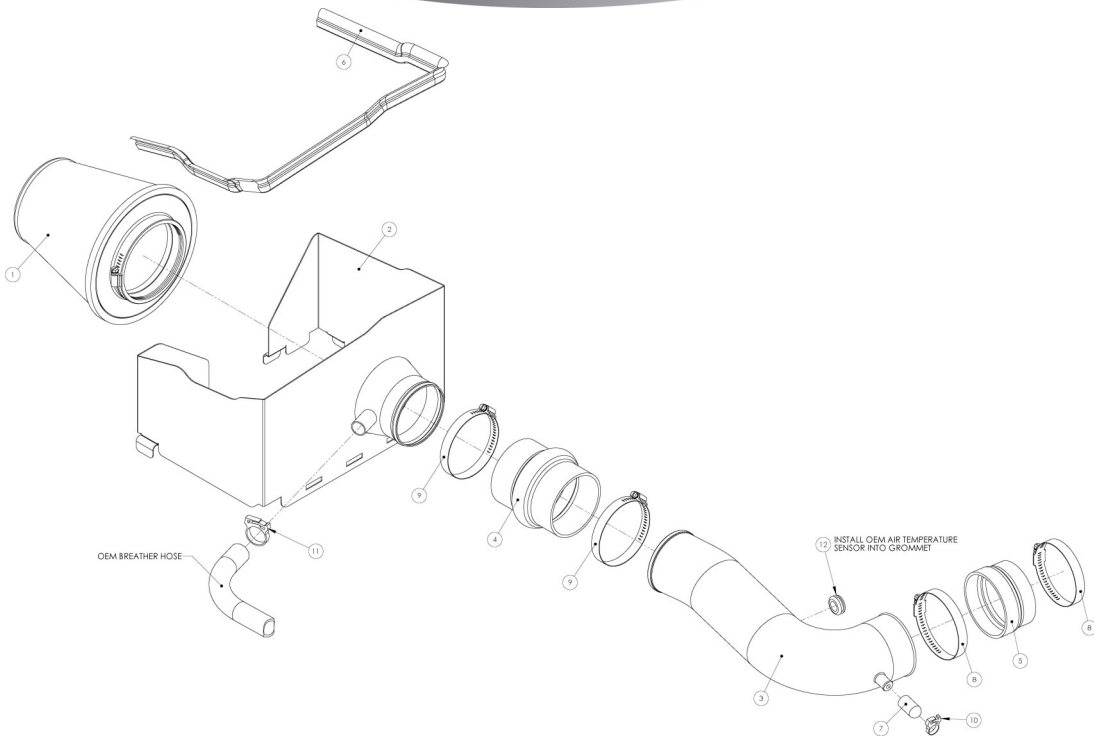

Full color instructions can be viewed on our web site at Airaid.com. Use the **Product Search** function to find your part number, and click **View Details**.



1. **Disconnect the negative battery cable!** Loosen the hose clamp on the resonator. Dis-

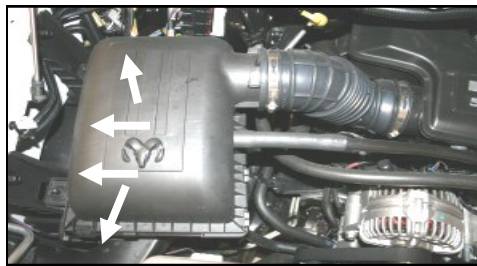

2. Unlatch 4 clips on the factory airbox lid and remove the lid and intake hose assembly. Re-

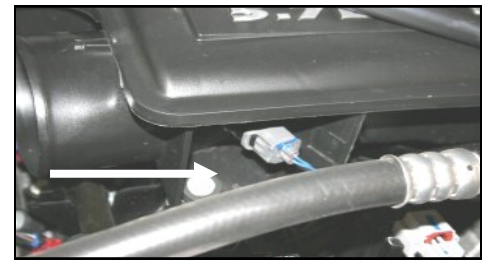

3. Squeeze the tab on the connector, and disconnect the intake temperature sensor.



4. Using a 10mm socket, remove two bolts holding the intake resonator to the intake manifold. Lift and pull the resonator away from the



5. Remove the factory seal from the throttle body.



6. Gently twist the air temperature sensor counterclockwise and remove it from the

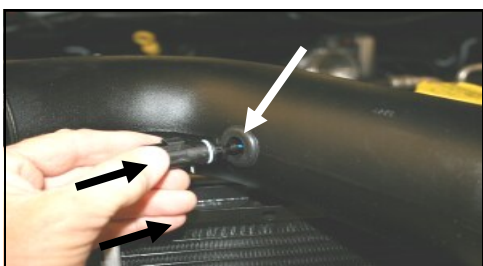

7. Install the supplied grommet (#12) into the Modular Intake Tube (#3). Next, carefully slide the factory temperature sensor into the grommet until it touches the tab on the temperature



8. Install the Quick Fit Panel (#2) onto the factory airbox base by sliding the tabs on the base thru the Quick Fit Panel and then adjust the sides to fit. Re-latch the 4 clips to hold the Quick Fit Panel securely in place. Apply the Airaid Foil Decal onto the Panel as shown.

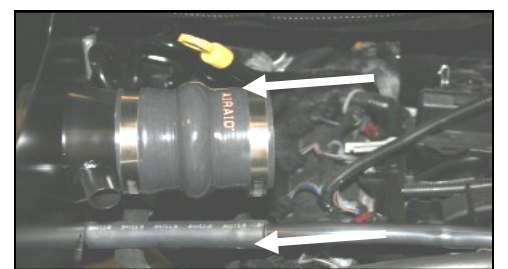

9. Install the urethane hump hose (#4) onto the tube on the Quick Fit Panel using two



10. Install the reducing coupler (#5), small end first, onto the throttle body using two #52 hose clamps (#8). Leave the clamps loose for now.



11. Install the Modular Intake Tube (#3) into the hump hose first and then into the reducing coupler. Adjust for fit, and then tighten all 4 hose clamps.

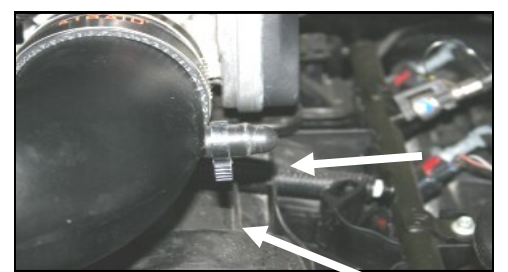

12. Install the provided rubber cap (#7) and speed clamp (#10) onto the nipple on the Modular Intake Tube, as shown.



13. (Note: Because factory production tolerances vary, it may be necessary to remove the tape on the wiring loom and pull out 1 1/2" of wire to the temp sensor, and then re-install the tape. Re-connect the wiring harness to the temperature sensor.



14. Install the Airaid Premium Filter (#1) onto the tube on the Quick Fit Panel and tighten the clamp. Next install the weather strip (#6) on the top of the Quick Fit Panel as shown. (Hint: Start at one end of the Quick Fit Panel and work your way towards the other end.)

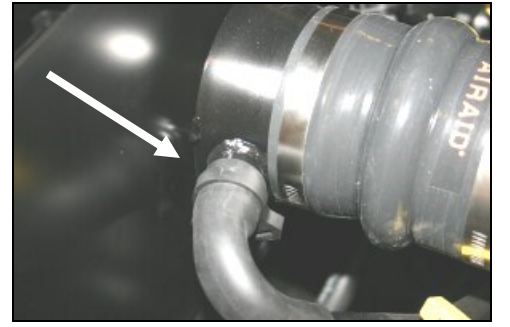

15. Slip the #24 speed clamp (#11) over the factory breather hose and re-connect the factory breather hose to the nipple on the Quick Fit Panel. Squeeze the clamp to retain the hose in place.

16. Double check your work!

Make sure there is no foreign material in the intake path. Make sure all clamps, hoses, fasteners, and wiring connections are tight.

17. Reconnect the negative battery cable!

Thank you for purchasing the Airaid Intake System. Contact Airaid @ (800) 498-6951 8:00 AM - 5:00 PM MST weekdays for questions regarding fit or instructions that are not clear to you. Your Airaid Intake System was carefully inspected and packaged. Check that no parts are missing, or were damaged during shipping. If any parts are missing, contact Airaid. The air filter element is protected from direct exposure to water and debris; care should be taken not to drive through deep water. WATER INGESTION IS THE DRIVERS RESPONSIBILITY! The air filter is reusable and should be cleaned periodically.

FILTER IDENTIFICATION

700-445 Airaid Oiled Media
702-445 Airaid SynthaMax Dry Media - Black

701-445 Airaid SynthaMax Dry Media - Red
703-445 Airaid SynthaMax Dry Media - Blue

**For your Oiled media filter
we suggest using the AIRAID
Filter Tune-Up Kit!**



P/N 790-551 Aerosol Spray
P/N 790-550 Squeeze Spray



Do Not Oil

Synthamax Air Filters do not require oil. Service air filter as needed by cleaning with common non-petroleum all-purpose household cleaner and water. Simple Green®, Formula 409® or equivalent works great. Apply cleaner to outside of air filter and allow to soak. Then flush filter clean from the inside out with a garden hose and repeat steps if necessary. Do not apply high pressure water or air to clean filter. Allow filter to air dry and reinstall.

