



Installation Instructions

For Part Numbers:

250-332 700-461 Airaid Oiled Media Filter

251-332 701-461 SynthaMax Dry Media Filter - Red

2016-19 Chevrolet Camaro 3.6L V6

NOT LEGAL FOR SALE OR USE ON ANY POLLUTION CONTROLLED MOTOR VEHICLE IN CALIFORNIA OR STATES ADOPTING CALIFORNIA EMISSION PROCEDURES.

See AIRAID.COM for CARB status on each part for a specific vehicle.

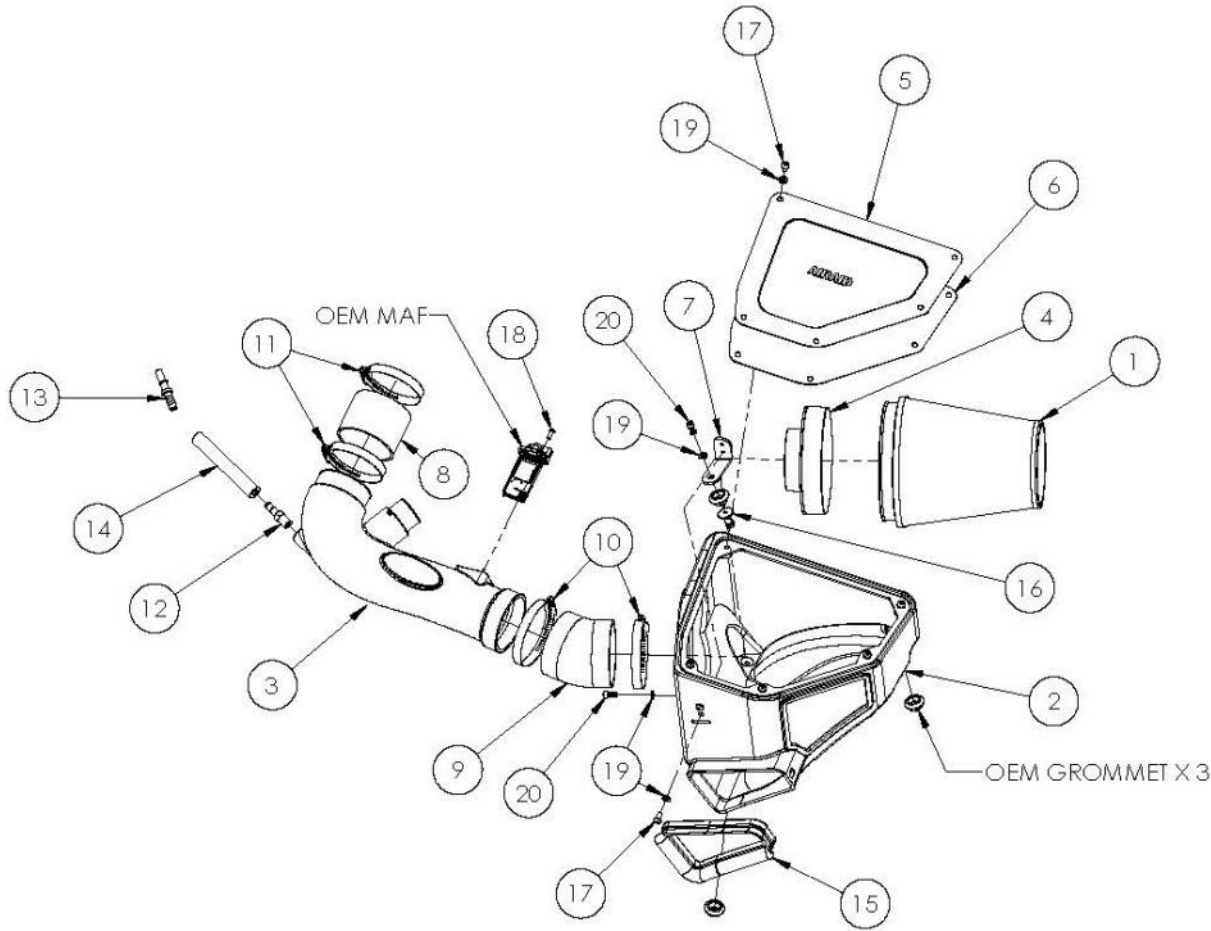

Component Identification

1	700/701-461	Airaid Premium Filter	1
2	KIT332CAB	Airaid Intake Airbox	1
3	KIT332	Airaid Intake Tube	1
4	21512-1	Filter Adapter	1
5	KIT333LID	Airaid Airbox Lid	1
6	KIT333G	Airbox Lid Gasket	1
7	KIT333BC	Airbox Bracket	1
8	KITCOUPLER16	Coupler	1
9	KITELBOW15	Elbow	1
10	08620	#56 Hose Clamp	2
11	08601	#48 Hose Clamp	2
12	08047	3/8" Barbed Fitting	1
13	82631	8" Quick Disconnect Fitting	1
14	08717	3/8" ID Hose	1
15	KITSTRIP36	1.54 ft. Weatherstrip	1
16	8-186-1	Airbox Mount	1
17	KIT15DHC3050	1/4-20 Button Head Screw	7
18	KIT15BHC3050	8-32 Button Head Screw	2
19	AEM-1-3016	Flat Washer	10
20	KIT61SS12SHSCS	Socket Head Cap Screw	3
21	KITSTICKER12	Airaid Badge	1
22	KITPLUG03	Firewall Plug (Not Shown)	1

Full color instructions can be viewed on our web site at Airaid.com. If you need any assistance please call 1-800-858-3333 to speak with a representative in our Customer Service Center before returning the product.



1. Inside the trunk, on the passenger side, locate and remove the battery access panel. Disconnect the Negative battery terminal.

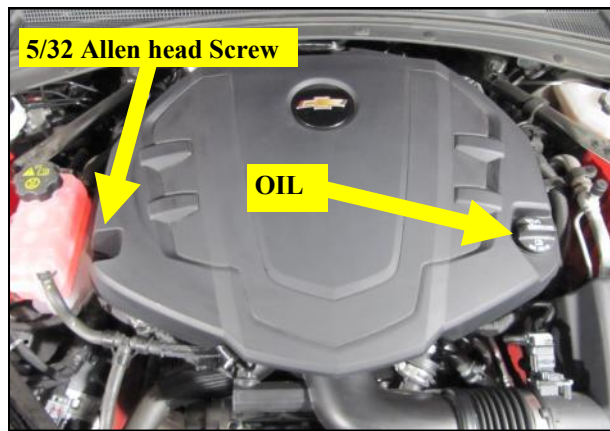

2. Remove the oil cap and engine cover. Reinstall the oil cap for the remainder of the install.

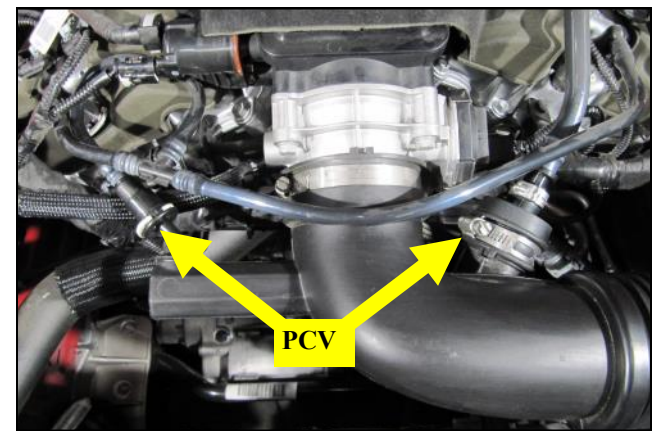

3. Disconnect the PCV breather lines from the intake tube.



4. Loosen the clamps on the intake tube and remove it from the vehicle.



5. Disconnect the resonator tube from the bottom of the factory intake tube.

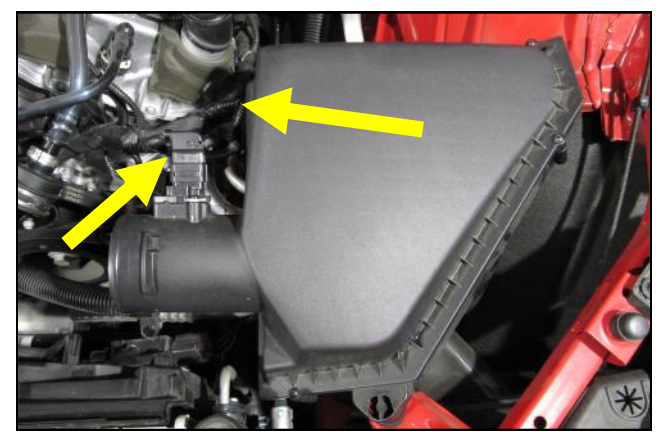

6. Disconnect the Mass Airflow sensor and gently pry the harness anchor out of the airbox. Remove the airbox assembly from the vehicle. Ensure that all three airbox grommets remain in the inner fender and not on the airbox.

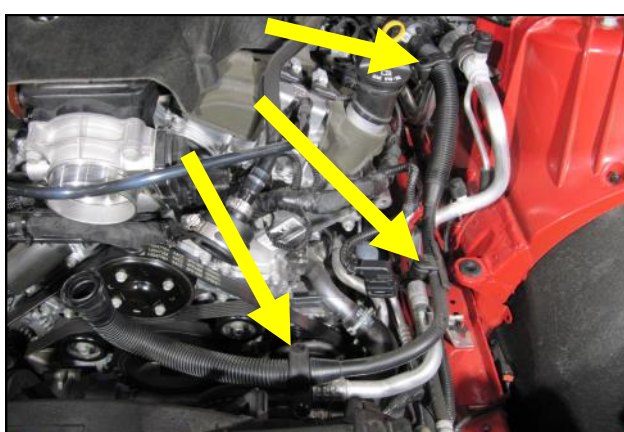

7. Disconnect the resonator tube retainers on the along A/C line, all the way up to the strut tower.

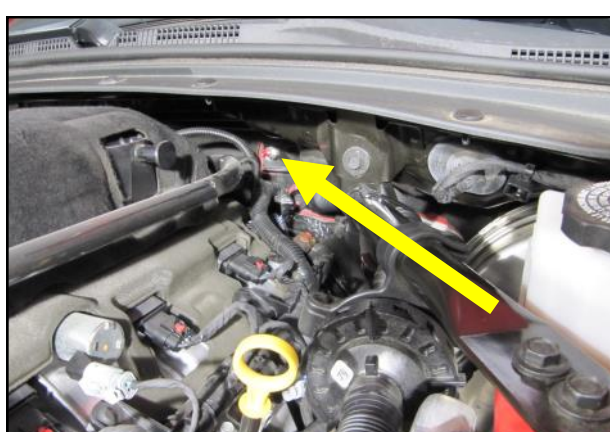

8. At the firewall, remove the 6mm flange nut at the resonator tube base. Turn the tube 1/4 turn Clockwise and remove it from the vehicle.

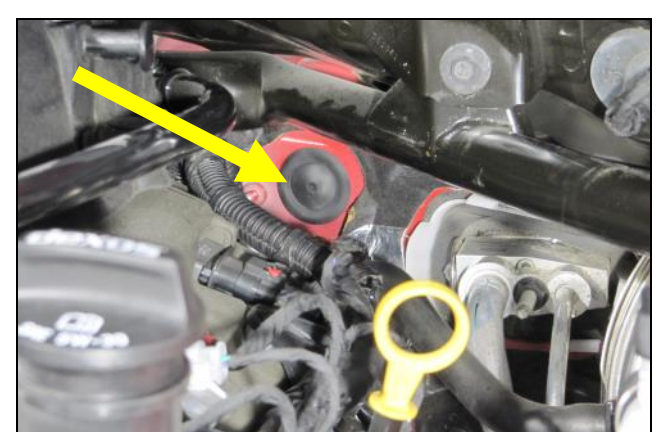

9. Insert the Firewall Plug into the resonator tube hole.

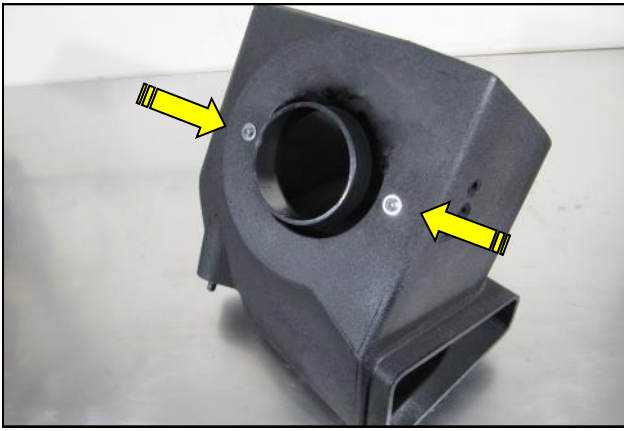

10. Mount the Filter Adapter inside of the Airbox as shown, using two sets of 6mm Socket Head Screws and Flat Washers.

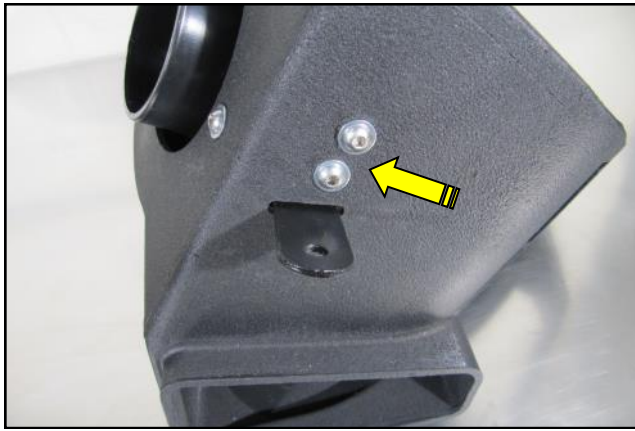

11. Slide the Airbox Bracket into the slot above the air inlet, from inside the box, and secure it using two sets of 1/4-20 Button Head Screws and Flat Washers.

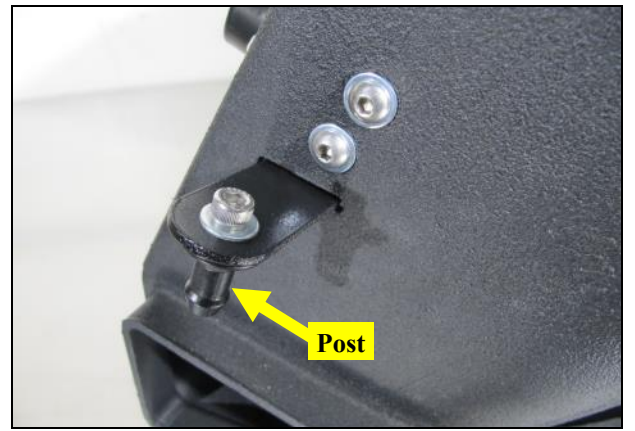

12. Install the Airbox Mounting Post onto the Bracket, as shown using the remaining 6mm Screw and one Flat Washer.



13. Install Weatherstrip onto the Airbox inlet, with the contour flaring out. Trim any excess for a proper fit.

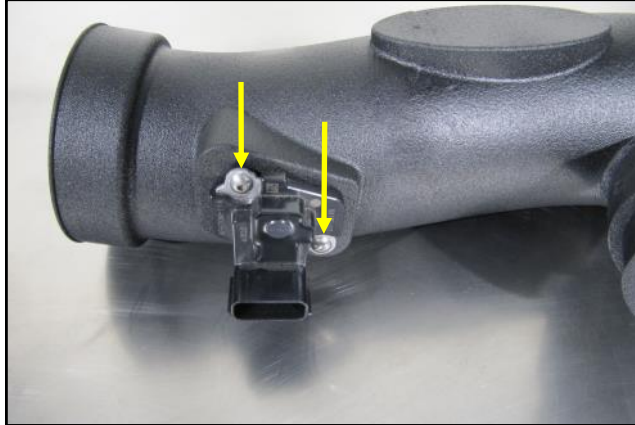

14. Transfer the MAF Sensor from the factory airbox, into the Airaid Intake Tube and secure it using the supplied #8 Button Head Screws.

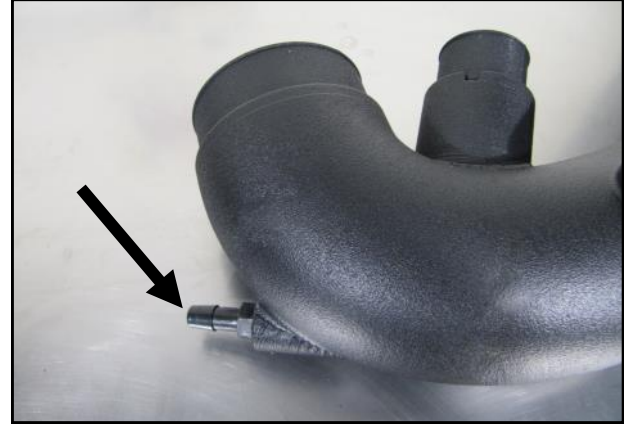

15. Install the Barbed Fitting into the Intake Tube as shown.

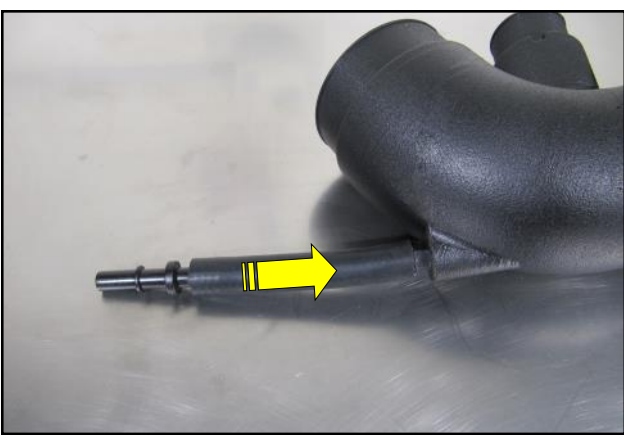

16. Insert the PCV fitting into the supplied Hose and connect it to the Barbed Fitting on the Tube.



17. Prepare the Intake Tube for Badge installation by cleaning the mounting surface using a Prep Solvent or equivalent. Place the Airaid Badge onto the Intake tube as shown.



18. Place the Airaid Airbox assembly into the engine compartment as shown, with the mounting posts only fully seated in all three grommets.

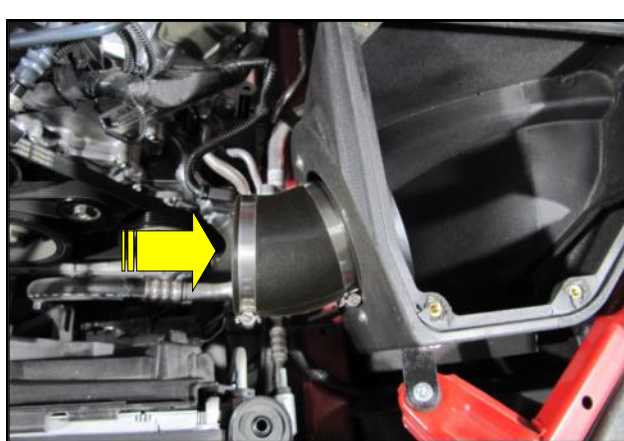

19. Slide the Elbow and #56 Clamps onto the Filter Adapter.



20. Slide the Coupler and #48 Clamps onto the throttle body as shown.



21. Insert the Intake Tube into the Elbow first, then into the Coupler. Tighten all four Clamps.

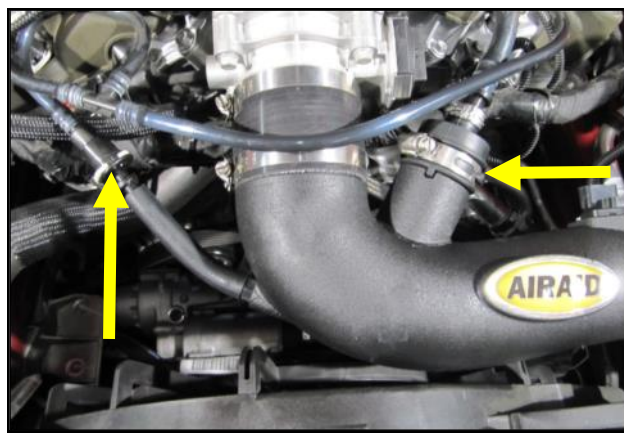

22. Connect the PCV breathers to the Airaid Intake Tube.



23. Reconnect the Mass Airflow sensor.



24. Install the Air Filter onto the filter adapter, inside the Airbox.

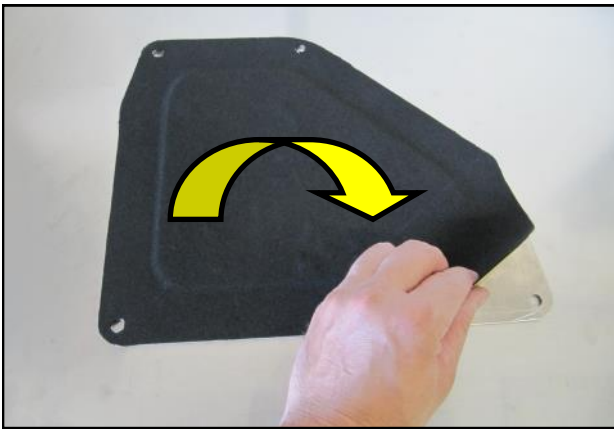

23. Prepare the Airbox Lid for Gasket installation by cleaning the mounting surface using a Prep Solvent or equivalent. Remove the adhesive backing from the Gasket and carefully apply it as shown with the screw holes aligned.



26. Remove the protective film from the other side of the Lid and mount it to the Airbox using 5 sets of 1/4-20 Button Heads and Flat Washers.



26. Replace the engine cover and oil cap. Slowly lower the hood to test clearances. Make sure all clamps, hoses, bolts, and screws are tight. Double check the hood clearance. Reconnect the negative battery terminal and re install the access panel.

FILTER IDENTIFICATION

700-461 Airaid Oiled Media

701-461 Airaid SynthaMax Dry Media - Red

Thank you for purchasing the Airaid Intake System. Contact Airaid @ (800) 498-6951 8:00 AM - 5:00 PM MST weekdays for questions regarding fit or instructions that are not clear to you. Your Airaid Intake System was carefully inspected and packaged. Check that no parts are missing, or were damaged during shipping. If any parts are missing, contact Airaid. The air filter element is protected from direct exposure to water and debris; care should be taken not to drive through deep water. WATER INGESTION IS THE DRIVERS RESPONSIBILITY! The air filter is reusable and should be cleaned periodically.

**For your Oiled media filter
we suggest using the AIRAID
Filter Tune-Up Kit.**

P/N 790-551 Aerosol Spray
P/N 790-550 Squeeze Spray



SynthaMax

Do Not Oil

Synthamax Air Filters do not require oil. Service air filter as needed by cleaning with common non-petroleum all-purpose household cleaner and water. Simple Green®, Formula 409® or equivalent works great. Apply cleaner to outside of air filter and allow to soak. Then flush filter clean from the inside out with a garden hose and repeat steps if necessary. Do not apply high pressure water or air to clean filter. Allow filter to air dry and reinstall.



NOT LEGAL FOR SALE OR USE ON ANY POLLUTION CONTROLLED MOTOR VEHICLE IN CALIFORNIA OR STATES ADOPTING CALIFORNIA EMISSION PROCEDURES.

See AIRAID.COM for CARB status on each part for a specific vehicle.