

CUSTOMIZATION

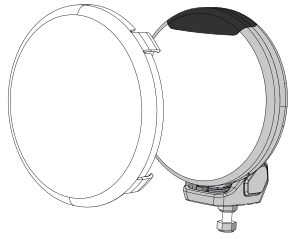

LENS PROTECTOR REMOVAL

Remove Lens Protector by un-clipping the side wings.

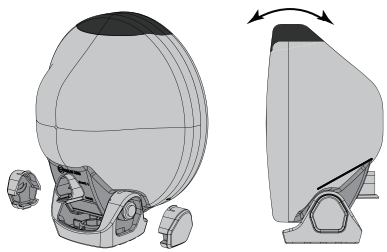

ANGLE ADJUSTMENT

Remove the endcaps, loosen the Nyloc nut and adjust the lamp to the desired angle. Re-tighten Nyloc nut and re-fit endcaps.

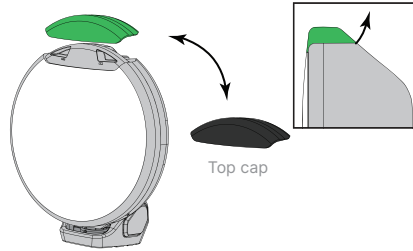

TOP CAP COLOR CHANGE

- 1 Remove top cap by un-clipping it from the back edge of the light.
- 2 Change the color top cap. Reassemble in reverse order.

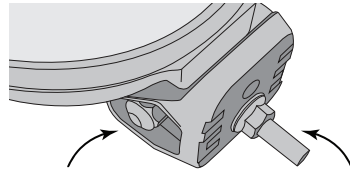

TORQUE SPEC.

10mm bolt:70/in-lb (8/N-m) (5.8/ft-lbs)



SERIES ONE FF.70

INSTRUCTIONS & SPECIFICATIONS

Model No. AL538800-1
AL538801-1



COMPONENTS

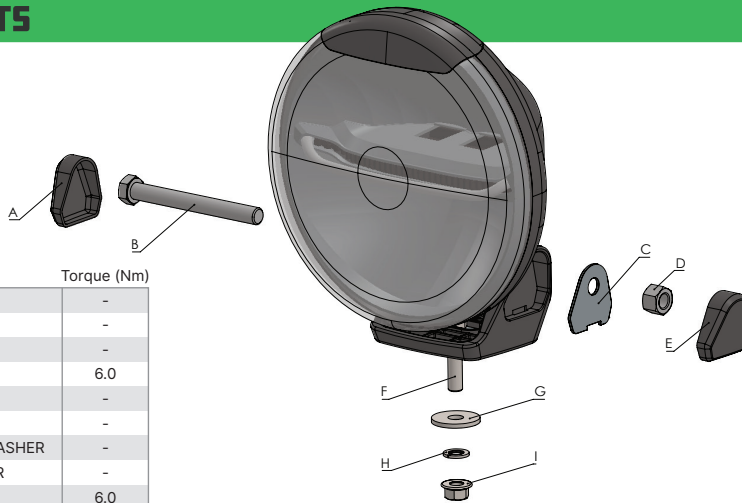

Item	Description	Torque (Nm)
A	CUSTOM SCREW CAP LH	-
B	M12 X 1.75 X 110mm HEX	-
C	CUSTOM PLATE	-
D	M12 NYLOC NUT	6.0
E	CUSTOM SCREW CAP RH	-
F	M10 X 1.5 X 40mm HEX	-
G	M10 X 30 X 2.5mm FLAT WASHER	-
H	M10 SPRING LOCK WASHER	-
I	M10 FLANGE NUT	6.0

IMPORTANT SAFETY INFORMATION

- Remove negative battery cable before installation.
- Ensure lights are fitted using the appropriate wiring harness or an equivalent auxiliary wiring system.
- Ensure the lights are mounted securely to a solid surface on the vehicle.
- Cables connected to the light must not be subjected to wear or other damage.
- Do not operate device in proximity to flammable or combustible objects.



info@projectxoffroad.com

(866) 294-9244

Mon-Sat 8am-5pm PST

TECHNICAL SPECIFICATIONS

Voltage: 9-33V

LEDs: 2 x 15 Watt XHP50.2 Cree® LEDs

Housing & Bracket: Extra tough fiber reinforced polymer

Beam Type: Flood or spot beam

Lenses: Hardcoated Polycarbonate

Color Temperature: 5000°K

Current Draw: 3A at 12V per light

WIRING

Every Install is unique and we provide simple installation information but professional installation is highly recommended.

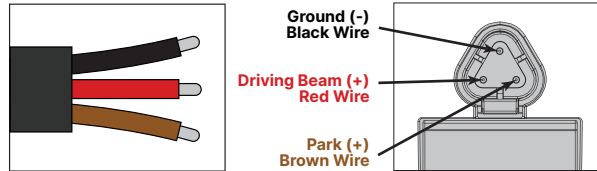

A Horizon Brands Company
2975 Red Hill Ave, Ste. 100, Costa Mesa, CA 92626
Copyright © 2022 ADC Solutions Auto, LLC. All rights reserved.

Follow manufacturer's instructions to ensure the product is properly & safely installed. The manufacturer and seller are not responsible or liable for consequential, incidental, or indirect damages, whether to person or property, resulting from the installation or improper use of this product.

- Before installing, please make sure the Driving Lights are free from damage, fracture and no impurities.
- Considering the high intensity of light, DO NOT stare at the light when it is switched on.
- The surface of the LED will reach very high temperature when it is turned on.
DO NOT touch the surface directly to avoid severe burns.
- Do not install or use product if it, in any way, impairs the safe operation of your vehicle.

▲ WARNING: This product can expose you to chemicals including DEHP and DINP, which are known to the State of California to cause cancer and birth defects or other reproductive harm. For more information go to www.P65Warnings.ca.gov.

WARRANTY

This PROJECT X product carries a Limited Lifetime warranty against defects in workmanship and materials subject to the conditions and additional warranty information available at:

www.projectxoffroad.com/pages/returns-warranty

DISCLAIMER OF WARRANTIES, INCLUDING WARRANTY OF MERCHANTABILITY AND WARRANTY OF FITNESS FOR PARTICULAR PURPOSE: EXCEPT AS SPECIFICALLY SET FORTH HEREIN, NO WARRANTY OR REPRESENTATION, EXPRESS OR IMPLIED, IS MADE AS TO THE LED DRIVING LIGHT. PROJECT X AND/OR ITS AFFILIATES EXPRESSLY DISCLAIMS, WITHOUT LIMITATION, ANY STATUTORY WARRANTIES AND ALL IMPLIED WARRANTIES, INCLUDING ANY IMPLIED WARRANTY OF MERCHANTABILITY OR FITNESS FOR A PARTICULAR PURPOSE.

MOUNTING

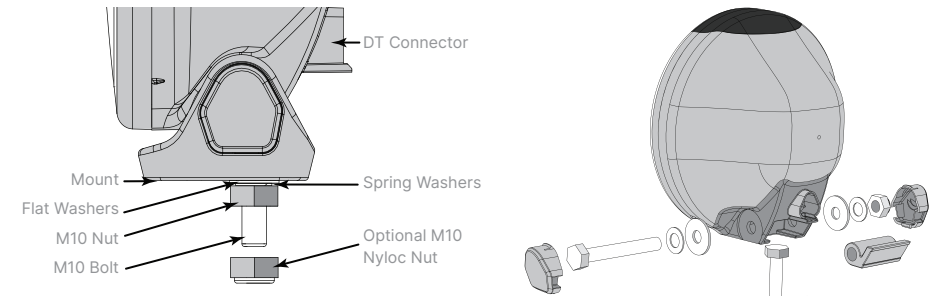

- 1 Each light is pre-assembled with stainless steel fasteners.
- 2 Choose a solid surface on the vehicle to mount the driving lights and secure the lights by using the flat washer, spring washer with M10 nut.
- 3 An optional M10 Nyloc nut is included to provide extra security and vibration resistance.

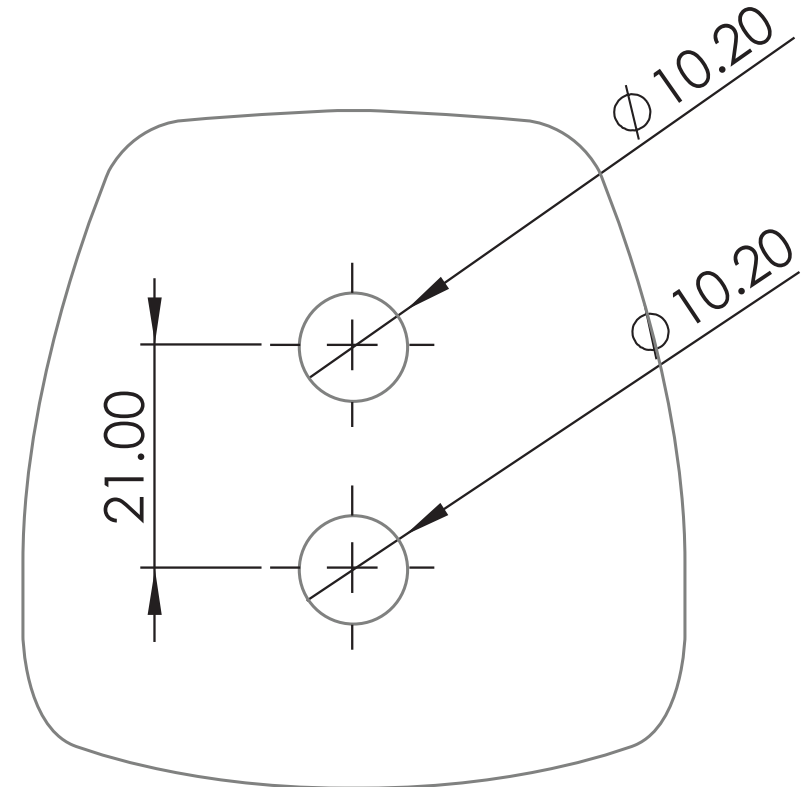

Not to scale