



Installation Instructions

Replace-a-Top

60th Anniversary Top

Vehicle Application:



- Jeep Wrangler CJ7
1976 – 1986
Part Number: 51118

NOTE Fits the OEM bows and door frames.

www.Bestop.com - We're here to help! Visit our web site and click on "[Ask a Question](#)". Click here for more [Jeep® Accessories by Bestop](#).

INSTALLATION TIME	SKILL LEVEL
 1 Hour	<div style="display: flex; justify-content: space-around;"> 1 2 3 4 </div> 1 - Easy

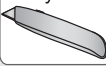

TOOLS		
Utility Knife 	Scissors 	Safety Glasses 

Installation Tips

Before you begin installing this assembly, read all instructions thoroughly.

For a smooth fit:

For ease in installation, the product should be installed at temperatures above 72° F. Below this temperature, the fabric may contract an inch or more, making it difficult to fit to the vehicle. It is normal for fabric to contract and wrinkle when stored in the shipping carton. Within a few days after installation, the fabric will relax and the wrinkles will disappear.

CAUTION Safety glasses should be worn at all times while installing this product.

WARNING This product is designed primarily to enhance the appearance of the vehicle and to shield the occupants from ordinary weather conditions. Do not rely in any way on the components of this product to contain occupants within the vehicle, or to protect against injury or death in the event of an accident. This product will not protect the occupants from falling objects. Never operate the vehicle in excess of manufacturer's specifications.

WEAR SEAT BELTS AT ALL TIMES

Read and follow, precisely, all installation instructions provided when installing product. Failure to do so may result in a poor fit and could place occupants of the vehicle in a potentially dangerous situation.

Replace-a-Top Installation Instructions

Parts List

Top Fabric	Qty - 1
Door Assembly - Right	Qty - 1
Door Assembly - Left	Qty - 1
5/8" x 2" Adhesive Hook Strip	Qty - 4
Bow Covers, Short	Qty - 2
Bow Covers, Long	Qty - 2

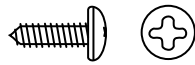

☐ #6 Sheet Metal Screw, Qty - 29,
Part Number 9.69

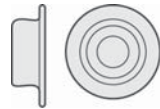

☐ Body Stud, Qty - 29,
Part Number 9.68

NOTE This kit contains a vinyl top and vinyl covers to fit the original equipment bows and door frames. You must have all of the original hardware for proper installation of the product. Should you be missing anything, consult your local vehicle dealer for replacement parts.

1 Remove Old Top

Remove the old top, including the horizontal and vertical rods and the bows.

NOTE This is the first step you must take in the installation process and it is also the most important one. Improper windshield adjustment results in poor fitting of both the top and the doors, as well as misalignment of snaps.

2 Windshield Adjustment

Measure and record the distance from the top lip of the windshield to the top outer edge of the vehicle body, but not the tailgate. Take the measurement from approximately six inches inside the vehicle's doors. Check to make sure that both sides measure equally. To install this top properly, this measurement must be 75 1/8".

If necessary, adjust your windshield by loosening the two screws in the Windshield Clamps located at the base of the windshield on each side of the vehicle. You may then lean the windshield forward or back as necessary. Use a shim to fix the windshield in place if it remains loose after you tighten the screws.

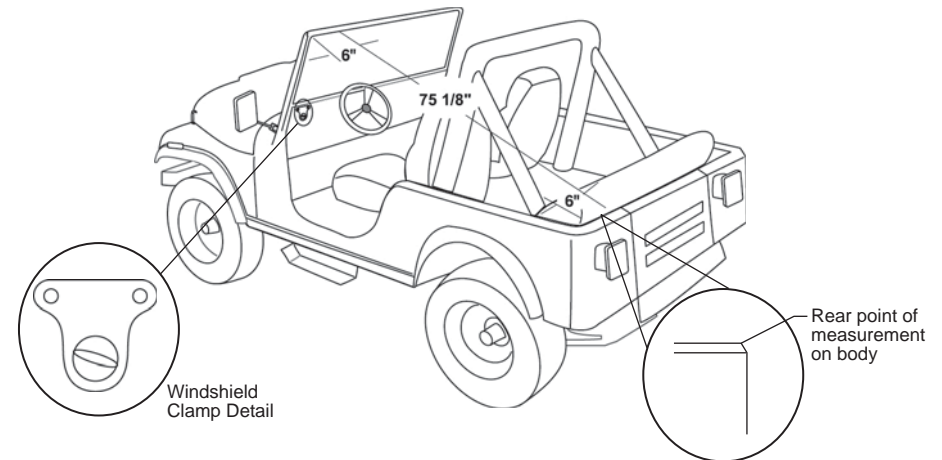
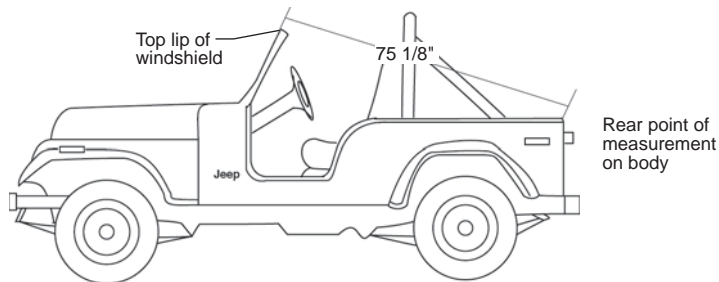

Replace-a-Top Installation Instructions

3 Install Bow Covers

Take the old bow covers off of the bows and slide on new ones. The long covers are for the rear bows and the short covers are for the front bows. Reinstall the bows on the vehicle.

4 Check Windshield Retainer Placement

The original equipment windshield retainer on 1976 and newer CJ5 and CJ7 vehicles should be installed so that the front edge of the retainer is flush with the front edge of the windshield frame. If the retainer sticks out in front of the windshield frame, it will not leave a space large enough to hold the top securely at high speed.

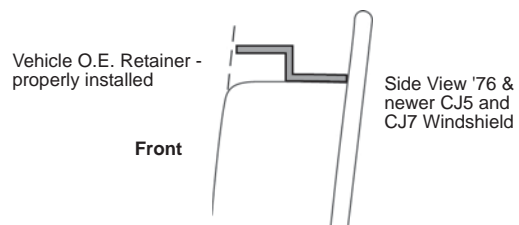

5 Install Top Fabric

Install the new top over the bows, just as the old one came off. Make sure that it is hooked securely under the retainer on top of the windshield frame. Snap the two short straps to the snaps in the rear bow and buckle the straps to the footman loops on the rear corners of the vehicle.

6 Install Horizontal and Vertical Rods

Insert the horizontal and vertical rods through the sleeves above the door openings. Snap the flap around the front bow to hold the rods in place.

7 Secure Top to Vehicle

Snap the top down to the vehicle body and the installation is finished.

NOTE The snap placement on the top is the same as the original top. However, due to the installation variances, fabric stretch and manufacturing tolerances, it is possible that some of the snaps will not line up exactly. Therefore, we have included a few extra snaps and screws for the body in case you should find it necessary to move one or more snaps. These may also be used if you have broken snaps from your original top.

NOTE On 1976 - 1977 models the snap placement on the vehicle body was along the slanted edge of the body. In 1978 the tops were made longer so that the snaps are placed approximately 1 5/8" below the top edge of the body. This top is designed to replace the longer (1978 and later) top. If you have one of the short (1976 - 1977) tops on your vehicle, it will be necessary to install new snaps in the body as shown. To do this, start at the rear corners of the vehicle and stretch the top tight to insure a wrinkle free fit..

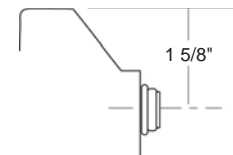
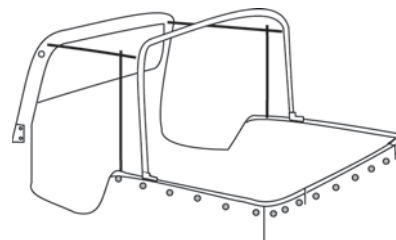

Replace-a-Top Installation Instructions

8 Remove Doors From Vehicle

To install the new fabric covers on the original door frames, first you must remove the old doors from your vehicle and take the door handles off.

NOTE Be careful in dismantling the handles, there is a spring inside each of the handles and they must be put back together just as they came apart.

9 Remove Door Covers

Use a utility knife to cut the stitching on the old door covers and remove them from the frames.

10 Install Door Covers

Start with the front of the door cover and locate the cut outs in the fabric for the door pins. Insert the door pins through the cut outs in the fabric and place the "First" corner into the pocket sewn into the fabric. Work around the door, slipping each corner into each corner of the elastic band. It may be necessary to unzip the upper window before sliding the elastic over the last corner.

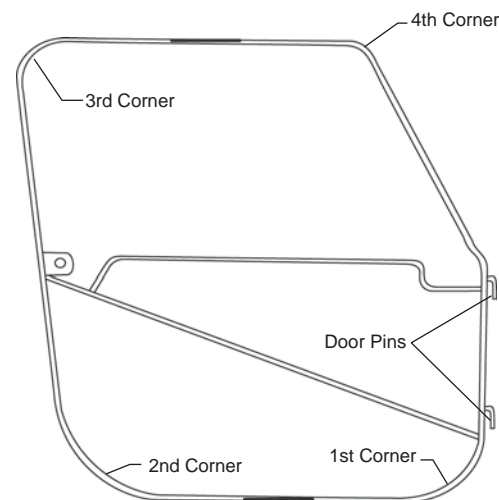

11 Secure Cover to Door Frame

After the fabric door covers are on the frames, install the adhesive hook on the door frame to match up with the loop strip sewn into the fabric cover. Snap the cover to the diagonal rod of the frame. Use a pair of scissors to cut a hole in each door for the handle and reinstall the handle. Make sure that you replace it the way it came off.

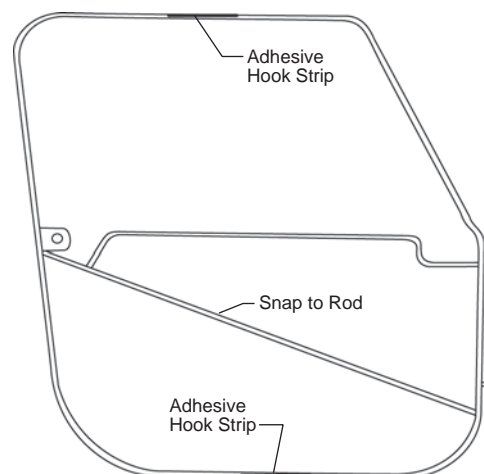

Replace-a-Top Installation Instructions

12 Folding the Top Down

Unsnap the rear and side curtains and unzip the rear curtain zippers. Roll the rear curtain to the inside and secure it to the top with the rear curtain straps. Unsnap the top from the body and remove both the Vertical and Horizontal Rods.

Fold the side curtain and lay it on top of the Top, folding along the seam. Then fold the rear curtain up over the side curtains. Push the Front Bow toward the Rear Bow.

Unfasten the Top from the windshield and lower the Top onto the vehicle as you push both Bows down and to the rear. Smooth out wrinkles and fold the Top in half from front to rear. You may then fold the Top to the back.

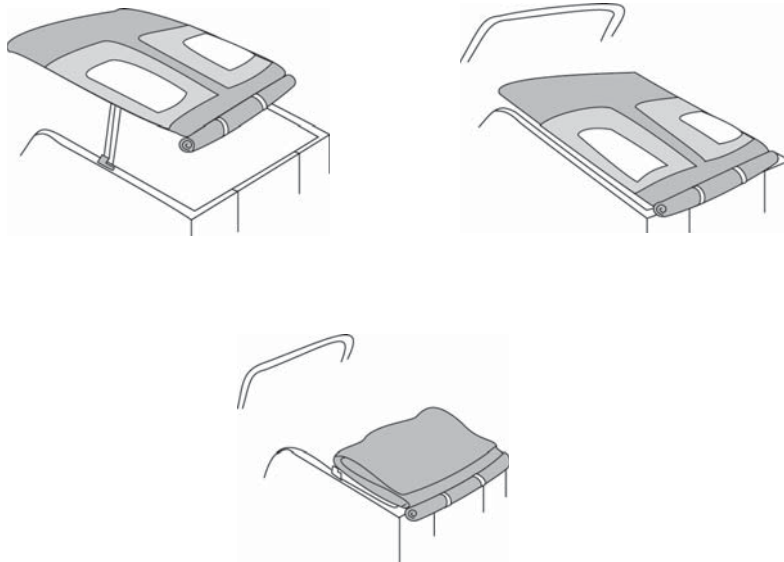

13 Storing the Top

Place sheets of paper over each window before storing. This will protect against scratches. Store the Top by folding and removing from vehicle. Keep the Top stored in its original shipping container in a cool, dry place.

Replace-a-Top Installation Instructions

Care and Maintenance of your Bestop Product

Your Bestop product is made of the finest materials available. To keep it looking new and for the maximum possible wear, it will need periodic cleaning and maintenance.

Fabric: The fabric should be washed often using soap, warm water and a soft bristle brush. Rinse with clear water to remove all traces of soap or use Bestop-recommended Bestop Cleaner and Bestop Protectant. Bestop Cleaner and Bestop Protectant are specially formulated to provide a total cleaning and protection system. Bestop Cleaner will not harm vehicle finish, is biodegradable and environmentally friendly. Bestop Protectant protects against UV-fading, cracking and hardening.

Windows: Keep windows clean to avoid scratching. DO NOT use a brush on the windows! Wash with a water-soaked cloth or sponge and a mild dishwashing detergent or use Bestop-recommended Bestop Vinyl Window Cleaner, which safely cleans and protects vinyl windows while helping prevent UV damage. NEVER WIPE THE WINDOWS WHEN THEY ARE DRY. Be careful when cleaning snow or frost from the vinyl windows since they are easily scratched and may crack at low temperatures. DO NOT roll the sides or rear window in cold weather. The windows become stiff and will crack. Cracks caused by misuse in cold temperatures are not covered under warranty.

Zippers: Keeping the zipper cleaned and lubricated with a silicone lubricant will help prevent damage and keep the zippers in a smooth working condition. If a zipper opens behind the slider, the slider may have been spread apart. This problem can usually be repaired by using an ordinary pair of pliers to bring the sides back into parallel. Return slider to the end of the zipper in the normal Open position. Squeeze lightly at first and test the zipper. If the zipper continues to remain open squeeze more firmly with the pliers and try the zipper again. Repeat this procedure until the zipper operates correctly.

Water: Seeping through at the seams may be stopped by applying 3-M Scotchgard® on the inside of the seams. Rips in the fabric may be repaired with Bondex® iron on patches. Iron the patches to the Inside of the top, carefully following the Bondex® instructions.

Snaps: Keep snaps cleaned and lubricated with silicone to help prevent snaps from sticking to the studs. If a snap does become stuck to a stud, use a screwdriver and GENTLY pry apart to prevent permanent damage to the snap or the top fabric.

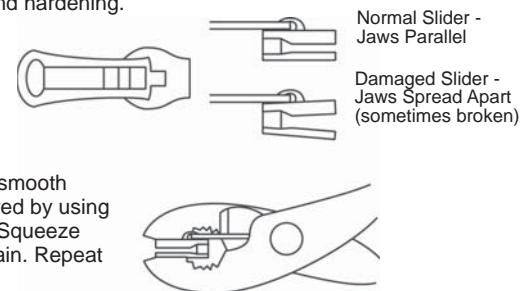

LIMITED WARRANTY

We warrant our product to be free from defects in material and workmanship, for the terms specified below, provided there has been normal use and proper maintenance. This warranty applies to the original purchaser only. All remedies under this warranty are limited to the repair or replacement of any item or items found by the factory to be defective within the time period specified. If you have a warranty claim, first you must call our factory at the number below for instructions. You must retain proof of purchase and submit a copy with any items returned for warranty work. Upon completion of warranty work, if any, we will return the repaired or replaced item or items to you freight prepaid. Damage to our products caused by accidents, fire, vandalism, negligence, misinstallation, misuse, Acts of God, or by defective parts not manufactured by us, is not covered under this warranty.

THE WARRANTY TIME PERIOD IS AS FOLLOWS FOR REPLACE-A-TOP™, SAILCLOTH REPLACE-A-TOP™, SUPERTOP®, SUPERTOP® REPLACEMENT SKINS, SUNRIDER®, AND TIGERTOP®: TWO YEARS FROM DATE OF PURCHASE.

THE WARRANTY TIME PERIOD IS AS FOLLOWS FOR ALL OTHER "SOFT GOODS" MANUFACTURED BY OUR COMPANY (USING PRIMARILY VINYL, PLASTICS, AND/OR FOAM): ONE YEAR FROM DATE OF PURCHASE.

THE WARRANTY TIME PERIOD IS AS FOLLOWS FOR ALL OTHER "HARD GOODS" MANUFACTURED BY OUR COMPANY (USING PRIMARILY METALS, PLASTICS, AND/OR FIBERGLASS): ONE YEAR FROM DATE OF PURCHASE.

ANY IMPLIED WARRANTIES OF MERCHANTABILITY AND/OR FITNESS FOR A PARTICULAR PURPOSE CREATED HEREBY ARE LIMITED IN DURATION TO THE SAME DURATION AND SCOPE AS THE EXPRESS WRITTEN WARRANTY. OUR COMPANY SHALL NOT BE LIABLE FOR ANY INCIDENTAL OR CONSEQUENTIAL DAMAGE.

Some states do not allow limitations on how long an implied warranty lasts, or the exclusion or limitation of incidental or consequential damages, so the above limitations or exclusions may not apply to you. This warranty gives you specific legal rights, and you may also have other rights which vary from state to state.



For further information or request for warranty work, please contact:
Bestop Inc., Customer Service
Toll-Free: (800)845-3567
Main: (303)465-1755
E-mail: csbestop@Bestop.com
Website: www.Bestop.com