

# INSTALLATION GUIDE



Part#: 121663

**HARDCORE LIMITED LIFETIME WARRANTY**

## **6.5" High Clearance Coilover Suspension System**

**Chevy/GMC 2500/3500 HD Pickup 2WD/4WD | 2020-23**

Rev. 121823

491 W. Garfield Ave., Coldwater, MI 49036 • Phone: 517-279-2135  
E-mail: [tech-bds@ridefox.com](mailto:tech-bds@ridefox.com)

# Read And Understand All Instructions And Warnings Prior To Installation Of System And Operation Of Vehicle.



## THANK YOU

Your truck is about to be fitted with the best suspension system on the market today. That means you will be driving the baddest looking truck in the neighborhood, and you'll have the warranty to ensure that it stays that way for years to come. Thank you for choosing BDS Suspension!

### BEFORE YOU START

BDS Suspension Co. recommends this system be installed by a professional technician. In addition to these instructions, professional knowledge of disassembly/ reassembly procedures and post installation checks must be known.

### FOR YOUR SAFETY

Certain BDS Suspension products are intended to improve off-road performance. Modifying your vehicle for off-road use may result in the vehicle handling differently than a factory equipped vehicle. Extreme care must be used to prevent loss of control or vehicle rollover. Failure to drive your modified vehicle safely may result in serious injury or death. BDS Suspension Co. does not recommend the combined use of suspension lifts, body lifts, or other lifting devices. You should never operate your modified vehicle under the influence of alcohol or drugs. Always drive your modified vehicle at reduced speeds to ensure your ability to control your vehicle under all driving conditions. Always wear your seat belt.

### BEFORE INSTALLATION

- Special literature required: OE Service Manual for model/year of vehicle. Refer to manual for proper disassembly/reassembly procedures of OE and related components.
- Adhere to recommendations when replacement fasteners, retainers and keepers are called out in the OE manual.
- Larger rim and tire combinations may increase leverage on suspension, steering, and related components. When selecting combinations larger than OE, consider the additional stress you could be inducing on the OE and related components.
- Post suspension system vehicles may experience drive line vibrations. Angles may require tuning, slider on shaft may require replacement, shafts may need to be lengthened or trued, and U-joints may need to be replaced.
- Secure and properly block vehicle prior to installation of BDS Suspension components. Always wear safety glasses when using power tools.
- If installation is to be performed without a hoist, BDS Suspension Co. recommends rear alterations first.
- Due to payload options and initial ride height variances, the amount of lift is a base figure. Final ride height dimensions may vary in accordance to original vehicle attitude. Always measure the attitude prior to beginning installation.



Visit [560plus.com](http://560plus.com) for more information.

### TIRES AND WHEELS

#### 6.5" Kit:

- 37 x 12.50 on 17" x 9" w/ 4-1/2 to 4-5/8" Backspacing\*
- 37 x 12.50 on 18" x 9" w/ 4-1/2 to 4-5/8" Backspacing\*
- 38 x 13.50 on 20" x 9" w/ 5-1/2 Backspacing\*\*
- 37 x 12.50 on 20" x 9" w/ 4-1/2 to 5-1/2" Backspacing\*
- Larger than 20", use 20" wheel specs

\*\*Trimming is required.

\*Trimming may be required.

Stock 17", 18", and 20" wheels will not fit back on the vehicle once this suspension system is installed!"

### BEFORE YOU DRIVE

Check all fasteners for proper torque. Check to ensure for adequate clearance between all rotating, mobile, fixed, and heated members. Verify clearance between exhaust and brake lines, fuel lines, fuel tank, floor boards and wiring harness. Check steering gear for clearance. Test and inspect brake system.

Perform steering sweep to ensure front brake hoses have adequate slack and do not contact any rotating, mobile or heated members. Inspect rear brake hoses at full extension for adequate slack. Failure to perform hose check/ replacement may result in component failure. Longer replacement hoses, if needed can be purchased from a local parts supplier.

Perform head light check and adjustment.

Re-torque all fasteners after 500 miles. Always inspect fasteners and components during routine servicing.

# CONTENTS OF YOUR KIT

021693 - Front Box Kit		
Part #	Qty	Description
02363B	1	Rear Cross Member
03876	1	Differential Bracket - DRV
03877	1	Differential Bracket - Center
02371B	1	Differential Bracket - PASS
02372B	1	Differential Skid Plate
342701	1	Thread locker
70	1	Sleeve - Center Differential Bracket
3523BK	2	Bushing - Center Differential Bracket
099000	3	Cable Tie
585	1	Bolt Pack - Lower Control Arms
	2	18mm-2.50 x 120mm bolt class 10.9 yellow zinc
	2	18mm-2.50 x 140mm bolt class 10.9 yellow zinc
	4	18mm-2.50 prevailing torque nut yellow zinc
	8	3/4" SAE flat washer yellow zinc
586	1	Bolt Pack - Differential Drop
	6	1/2"-13 x 1-1/4" bolt grade 8 yellow zinc
	2	1/2"-13 x 1-1/2" bolt grade 8 yellow zinc
	2	1/2"-13 x 3-1/2" bolt grade 8 yellow zinc
	4	1/2"-13 prevailing torque nut yellow zinc
	12	1/2" SAE flat washer yellow zinc
	4	1-3/8"OD x 1/2"ID x 3/16" Thick Washers
	2	12mm-1.75 x 40mm bolt class 10.9 clear zinc
	1	9/16"-12 x 4" bolt grade 8 yellow zinc
	1	9/16"-12 prevailing torque nut yellow zinc
	2	9/16" SAE flat washer yellow zinc
	4	10mm-1.50 x 40mm bolt class 10.9 clear zinc
	4	10mm flat washer clear zinc

011516 - 6" Rear Box Kit - Non Overload		
011526 - 6" Rear Box Kit - With Overload		
Part #	Qty	Description
03884	1	2020 GM HD Rear Block - DRV
03885	1	2020 GM HD Rear Block - PASS
343251550QB	4	3/4 x 3-1/4 x 15-1/2 Square U-Bolt Black (011516 Only)
343141912QB	4	3/4 x 3-1/4 x 19-1/2 Square U-Bolt Black (011526 Only)
03901	1	Rear Brake Line Bracket
03900	1	ABS Line Bracket
099000	2	Cable Tie
N34FLG-B	8	3/4"-10 Serrated Flange Nut
873	1	Bolt Pack - Rear Brackets
	2	1/4"-20 x 1" Bolt - Grade 5 - Clear Zinc
	2	1/4"-20 Prevailing Torque Nut - Clear Zinc
	4	1/4" SAE Washer - Clear Zinc
	2	5/16"-18 x 3/4" Bolt - Grade 5 - Clear Zinc
	2	5/16"-18 Prevailing Torque Nut - Clear Zinc
	4	5/16" SAE Washer - Clear Zinc

021690 / 021691 - Knuckle Box Kits		
Part #	Qty	Description
03825	1	Steering Knuckle - DRV (021690 Only)
03826	1	Steering Knuckle - PASS (021691 Only)
590	1	Bolt Pack
	6	Wire Clamp
	6	1/4"-20 x 5/8" Bolt, Grade 5
	6	1/4" Lock Washer
	6	6mm Washer (12mm OD)

021692 - Front Box Kit		
Part #	Qty	Description
03879	1	Front Cross Member
02373B	1	Cross Member Brace
22533D	1	Front Brake Line - DRV
22533P	1	Front Brake Line - PASS
5188	2	Brake Line Clip
CCW-03-050	4	Brake Line Crush Washer
65	2	.750 x .134 x 1.650 DOM Sleeve
162	2	0.750 x 0.134 x 1.255 Sleeve
M03212-BK-01	2	Offset Polyurethane Spacer
A361	2	Front Sway Bar Links
870	1	Bolt Pack
	2	12mm-1.75 x 80mm bolt class 10.9 clear zinc
	2	12mm-1.75 x 65mm bolt class 10.9 clear zinc
	4	12mm-1.75 prevailing torque nut clear zinc
	8	7/16" USS flat washer clear zinc
877	1	Bolt Pack - Front Brake Lines
	10	Wire Clamp
	8	1/4"-20 x 5/8" bolt grade 5 clear zinc
	8	1/4" lock washer clear zinc
	8	6mm flat washer - clear zinc

121301 - UCA Box Kit		
Part #	Qty	Description
A372	1	UCA Assembly - DRV
03913	1	Coilover Conversion UCA - DRV
500-1105	1	Ball Joint
02839	2	Bushing - UCA
02911	1	Aluminum Cap - Anodized
9452K145	1	O-ring (#139)
A373	1	UCA Assembly - PASS
03914	1	Coilover Conversion UCA - PASS
500-1105	1	Ball Joint
02839	2	Bushing - UCA
02911	1	Aluminum Cap - Anodized
9452K145	1	O-ring (#139)

**121661 - Skid Plate Box Kit**

Part #	Qty	Description
03902	1	Front Skid Plate
B1308	1	Bag Kit- BDS Badge

**021303 - LCA Box Kit - DRV**

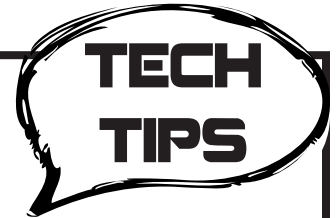
Part #	Qty	Description
A374	1	LCA Assembly - DRV
03915	1	Coilover Conversion LCA - DRV
K500232	1	Lower Ball Joint
MB08B700720	1	Rear Lower Bushing
MB08B700710	1	Front Lower Bushing
02802	1	BDS Large Logo
97525A430	2	18-8 SS Blind Rivet

**021304 - LCA Box Kit - DRV**

Part #	Qty	Description
A375	1	LCA Assembly - DRV
03916	1	Coilover Conversion LCA - DRV
K500232	1	Lower Ball Joint
MB08B700720	1	Rear Lower Bushing
MB08B700710	1	Front Lower Bushing
02802	1	BDS Large Logo
97525A430	2	18-8 SS Blind Rivet

**121663 - Coilover Conversion Box Kit**

Part #	Qty	Description
02392	4	Bump Stop Nut Plate
95105A159	3	3/8"-16 x .150 Matl. Rivet Nut
95105A168	3	3/8"-16 x .312 Matl. Rivet Nut
03906	1	Coilover Weld in Gusset Plate - Driver
03907	1	Coilover Weld in Gusset Plate - PASS
03911	2	Coilover Clearance Weld-in Plate
03871	1	Tie Rod Wrench
K750572	2	Sway Bar End Link
03904	1	Coilover Mount - DRV
03905	1	Coilover Mount - PASS
03908	2	CV Axle Spacer
401-2043	2	Heavy Duty Tie Rod Assembly
03909	1	Reservoir Mount - DRV
03910	1	Reservoir Mount - PASS
05359	4	Bump Stop Spacer - 1/4"
05240	1	Bump Stop - Front - Coilover
05241	1	Bump Stop - Rear - Coilover
891	1	Bolt Pack - CV Spacer
891	1	Bolt Pack - Coilover Conversion Hardware
871	1	Bolt Pack - Coilover Bump Stop
BP1041	1	Bolt Pack - Bump Stop Spacer

**IMPORTANT INFORMATION FOR YOUR VEHICLE**

- Models with two-piece rear drive shafts will require a carrier bearing drop kit. (BDS121612)
- Requires frame bracket modification.
- Disassembly/assembly of the factory torsion bar system requires the use of a special unloading tool. The GM specified tool # is CH48809.
- Compatible with diesel models ONLY. Works with standard or AT4 diesel models.
- Some minor trim will be required with certain wheel/tire combination. This is normal with most aftermarket tire/wheel fitment on Chevy/GM trucks. Trimming will normally include the bottom edge of the inner fender shrouds and/or lower corner of front bumper valance. As a rule of thumb, deeper backspacing and shorter/narrower tires will reduce/eliminate trimming required. Further trimming tips are included at the end of this instruction sheet.
- Factory 17-18" wheels cannot be reinstalled due to tie rod end interference, stock 20" wheels can be reinstalled with up to a 37x12.50 tire.
- In some cases vehicles used in 4WD on the highway regularly could potentially experience a minor front driveline vibration. If this occurs we recommend replacing the front driveshaft with a dual Cardan style driveshaft.
- Coilover coil has a large amount of preload, a coil spring compressor must be used to remove the coil from the coilover. Failure to use a coil spring compressor may result in death or injury.
- Do NOT increase coilover preload.
- For replacement ball joints use service kit BDS081203. Ball joints are directional and must be installed with the 'dot' facing either inward or outward on the vehicle, otherwise damage may occur.
- This system can be lowered to 5" of lift if desired and paired with the corresponding rear block height (011416 w/o overload spring or 011426 w/ overload spring). A max of 1" of preload can be removed from the coilover to achieve around 5" of lift.
- Increase of 1" of track width per side (2" overall) is done to create a better travel range of the suspension to allow more droop travel from ride height along width helping the coilover clear the frame components.

# PRE INSTALLATION

---

## IMPORTANT

It is required that ride height measurements be taken before and after installation. Measure from the **WHEEL AXLE CENTER** up to the **FENDER LIP** of the wheel opening. Do this for all 4 wheels. Record measurements below.\*\*

### BEFORE

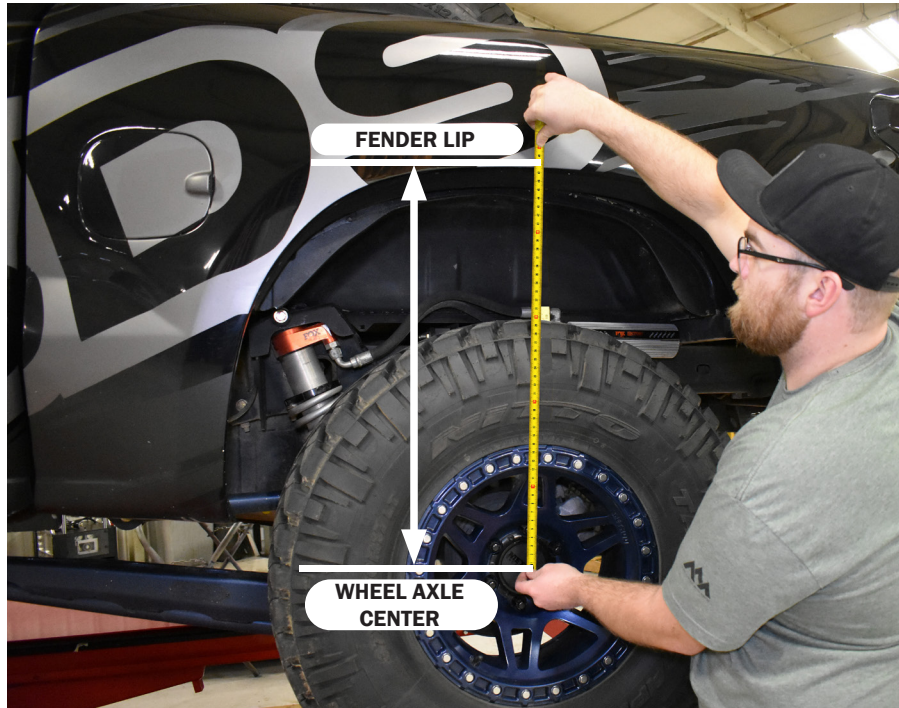
*Left Front* \_\_\_\_\_ *Right Front* \_\_\_\_\_

*Left Rear* \_\_\_\_\_ *Right Rear* \_\_\_\_\_

### AFTER

*Left Front* \_\_\_\_\_ *Right Front* \_\_\_\_\_

*Left Rear* \_\_\_\_\_ *Right Rear* \_\_\_\_\_



**\*\*These ride heights will be required if you have any ride height concerns after installation. Please be prepared to provide these to Technical Support.**

# INSTALLATION INSTRUCTIONS

## FRONT DISASSEMBLY

1. Park the vehicle on a flat, clean surface and block the rear wheels for safety.
2. Raise the front of the vehicle and support with jack stands under the frame rails.
3. Remove the wheels.
4. Measure and record the length of the exposed thread on the torsion bar adjuster bolts (Fig. 1). Record the lengths here for use later during the installation

## SPECIAL TOOLS

1-1/2" (38mm) socket/wrench  
36mm socket  
T30 Torx bit  
1-1/16" (27mm) socket/wrench  
Torsion Bar Unloading tool (see Pre-Installation Note #2)  
Reciprocating Saw  
4" Cut-off Wheel/Tool  
3/16" Rivet Gun

DRV Side: \_\_\_\_\_ PASS Side: \_\_\_\_\_

5. Unload the torsion bars but do not remove. Remove and discard the adjuster bolt/retainer block.



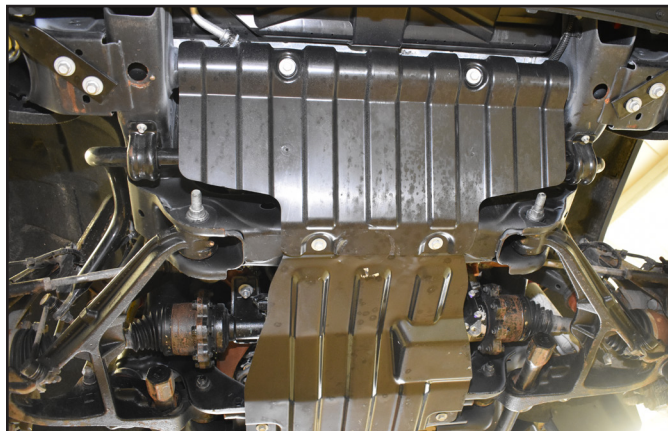
**Tip** Torsion bars are under extreme pressure. A proper torsion bar tool is necessary to unload the bars. A tool designed specifically for GM torsion bars is required see troubleshooting note #2.

**FIGURE 1**



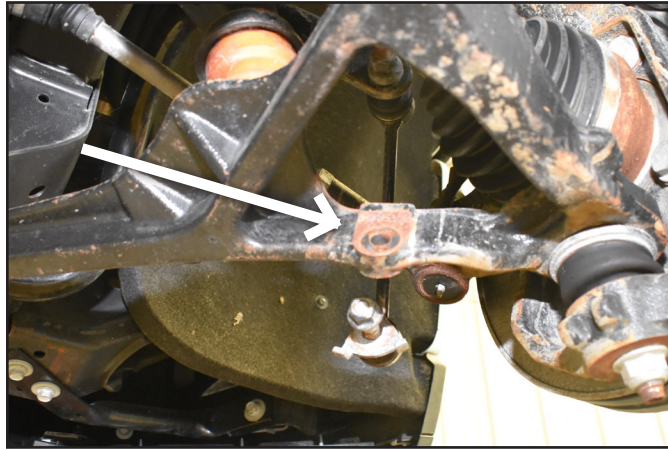
6. Mark the unloaded torsion bars to indicate DRV side and PASS side. Also mark the bars to indicate front versus rear.
7. Remove the torsion bar adjuster key by pushing the torsion bar forward to allow the key to drop free. On some vehicles this will require using a hammer/punch or air hammer. Access the end of the torsion bar through the hole in the back of the torsion bar cross member and drive forward. Leave the torsion bars in the lower control arms.
8. The torsion bar cross member can either be removed, allowing the torsion bars to be removed out the back of the vehicle. Or the torsion bar and lower control arms can be removed together later in the installation, leaving the torsion bar cross member in place.
9. If equipped, remove the four bolts mounting the factory belly pan to the frame and the two bolts mounting the front skid to the cross member (Fig. 2). These will not be reused.

**FIGURE 2**



10. Disconnect the sway bar end links from the sway bar and then the lower control arms (Fig. 3). Discard the link assemblies.

**FIGURE 3**



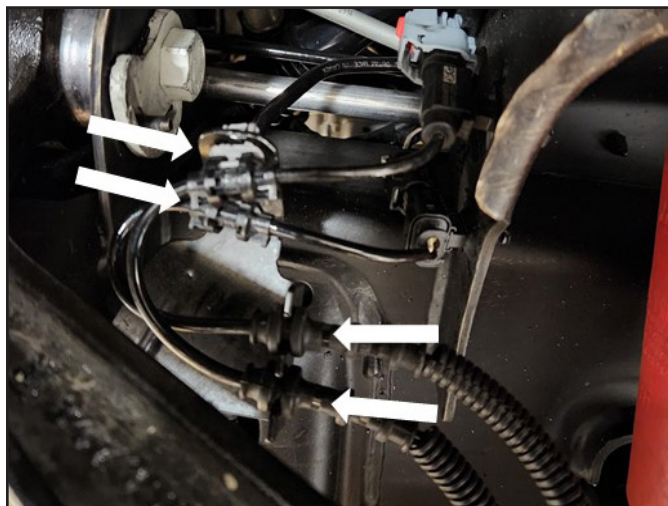
11. Disconnect the tie rod ends from the steering knuckles (Fig. 4). Remove the tie rod end nuts and save. Strike the knuckle near the tie rod end to dislodge the tie rod end taper. Remove the tie rod ends from the knuckles.

**FIGURE 4**

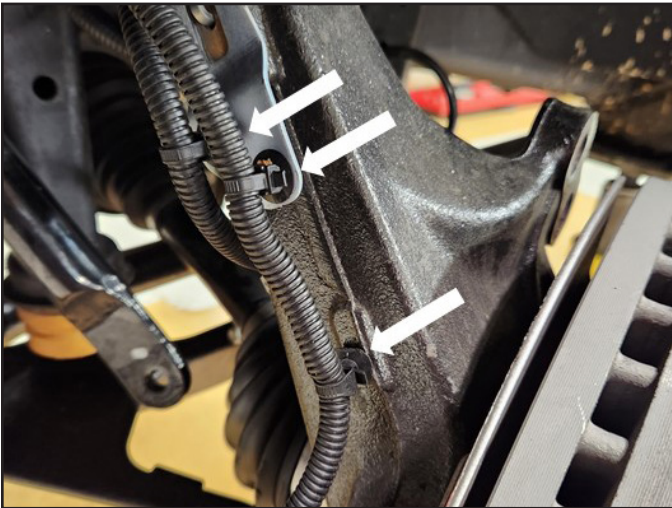


12. Remove the plastic retainers holding the ABS / brake wire to the brackets frame (Fig. 5) and the knuckle (Fig. 6a Fig. 6b) (Driver Side Shown). Leave the brackets attached to the frame and knuckle. Disconnect the ABS Sensor from the steering knuckle (Fig. 7).

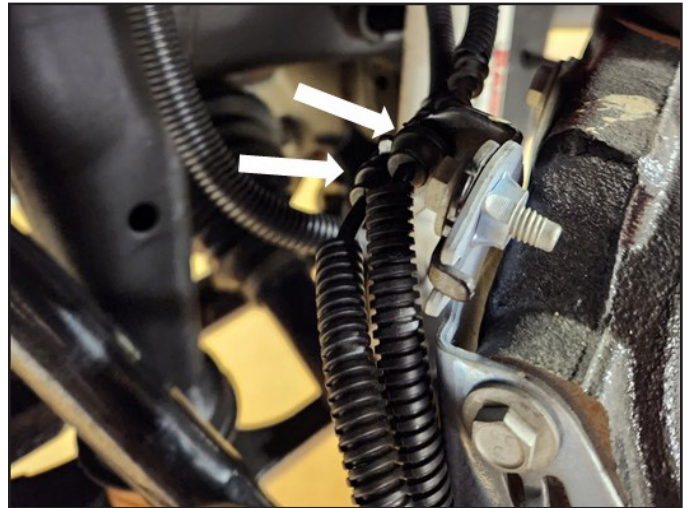
**FIGURE 5**



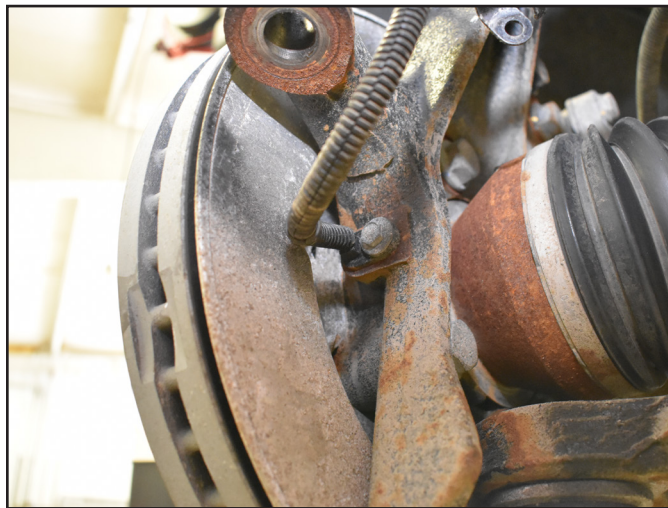
**FIGURE 6A**



**FIGURE 6B**



**FIGURE 7**



13. Remove the four bolts mounting the brake caliper assembly to the steering knuckle and hang the caliper out of the way (Fig. 8). Do not hang the caliper by the brake hose. Save mounting bolts.

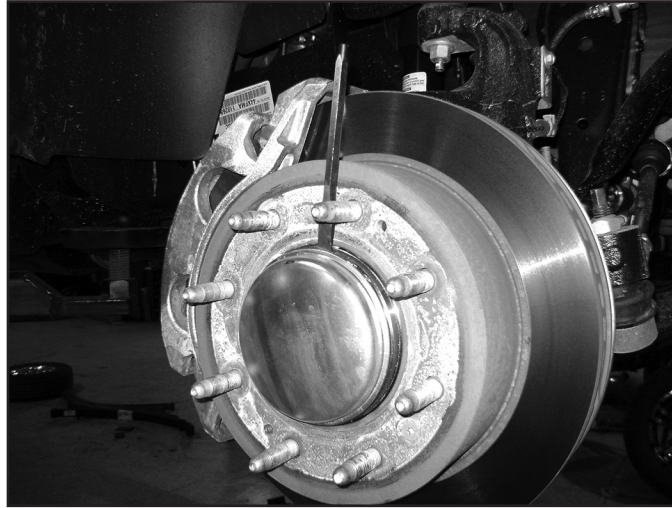
**FIGURE 8**





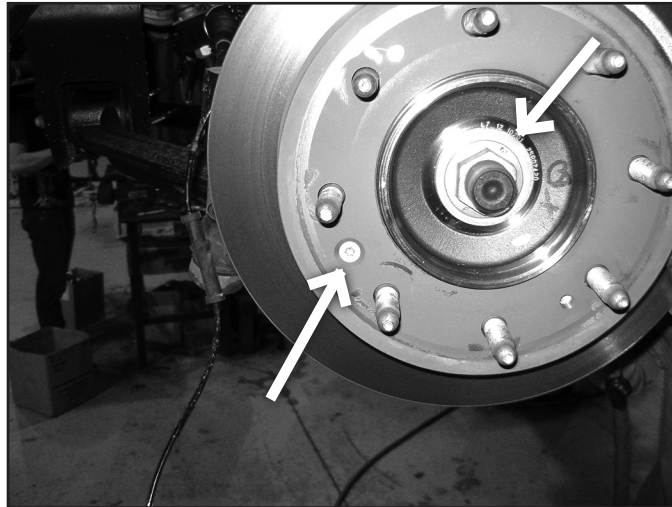
- Carefully remove the hub dust cover. Save cover (Fig. 9).

**FIGURE 9**



- Remove the rotor retaining bolt using a T30 torx bit (Fig. 10). Remove the brake rotor and set aside. Save retaining bolt.
- Remove the CV axle nut and washer (Fig. 10). Save hardware.

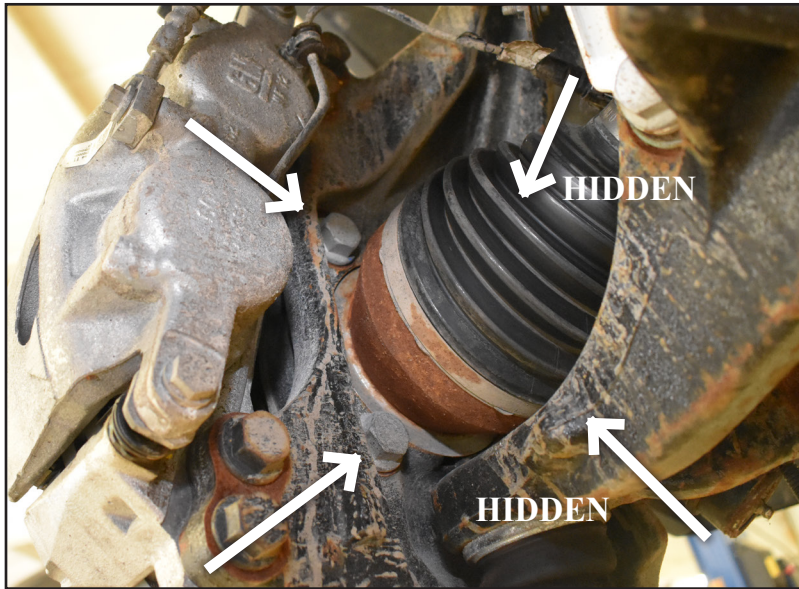
**FIGURE 10**



- Remove the upper ball joint nut. Reinstall the nut a couple of turns by hand. Strike the knuckle near the ball joint to release the taper. Remove the nut let the knuckle hang down. Take care not to strike the ball joint.

18. Locate and remove the four hub bearing assembly bolts (Fig. 11). The bolts are accessed from the back side of the steering knuckle. (Note: the CV axle may need to separate from the bearing to gain access to the bolts)

**FIGURE 11**



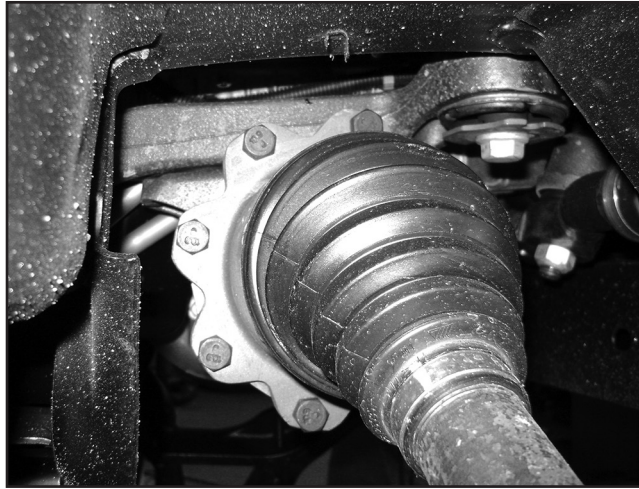
19. Remove the hub bearing assembly and dust shield from the steering knuckle. Take care not to damage to O-ring. Save dust shield, o-ring, and hub bearing for later installation.
20. Remove lower ball joint nut (Fig. 12). Reinstall the nuts a couple of turns by hand. Taking care not to strike the ball joint Strike the knuckle near the ball joints to release the taper. Remove the nut and remove the steering knuckle from the vehicle. Save nuts and the o-rings.

**FIGURE 12**



21. Remove the CV axle flange bolts at the differential (Fig. 13). There are 8 bolts per side. Remove the CV shafts from the vehicle and set aside. Discard bolts.

**FIGURE 13**



22. Disconnect the shocks from the frame (Fig. 14) and lower control arm (Fig. 15). Remove shocks. Save the upper and lower shock mount hardware.

**FIGURE 14**

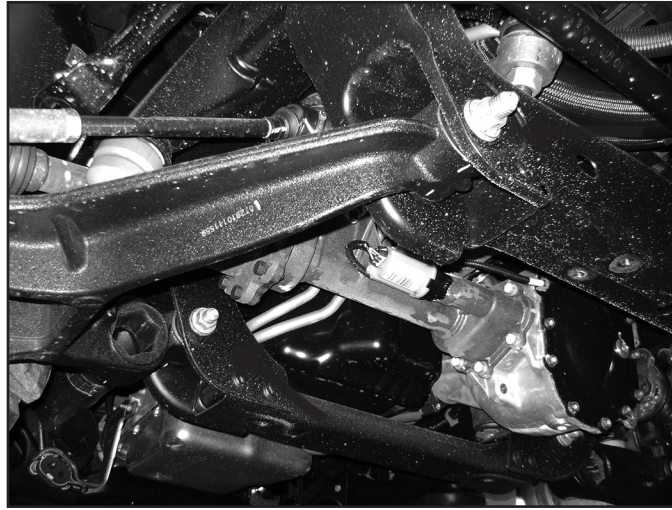


**FIGURE 15**



23. Remove the front and rear lower control arm bolts and remove the control arms from the vehicle (Fig. 16). Save the mounting hardware and discard the control arms.

**FIGURE 16**



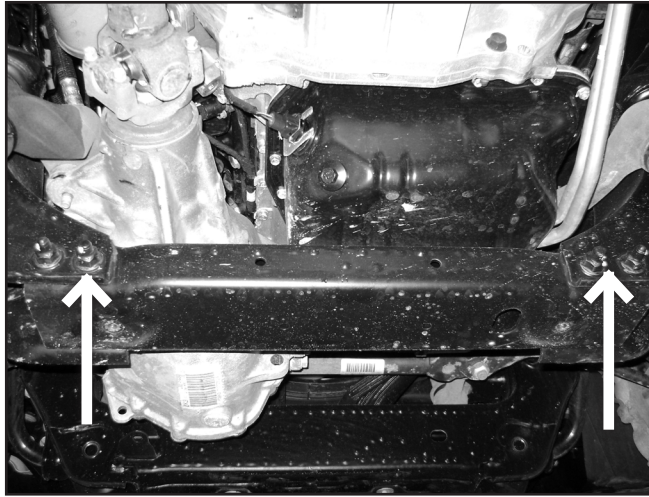
24. There are two factory bump stops per side. Remove the rubber bump stops from the frame mounts on each side. They can be removed with a pair of channel-lock pliers or by striking them with a rubber mallet. Save the bump stops for later installation.
25. Make an alignment mark on the front drive shaft and front differential input yoke. Remove the four bolts/clamps from the yoke and remove the front drive shaft from the differential (Fig. 17). Save the drive shaft hardware.

**FIGURE 17**



26. Remove the four bolts mounting the rear cross member to the rear lower control arm pockets (Fig. 18). Remove the cross member from the vehicle. The cross member and hardware will not be reused.

**FIGURE 18**



27. Disconnect the electrical connector from the front differential actuator (Fig. 19A). Remove the wire from the three plastic wire retainers along the top of the differential. Disconnect the axle breather tube from the top of the driver's side of the differential (Fig. 19B).

**FIGURE 19A**

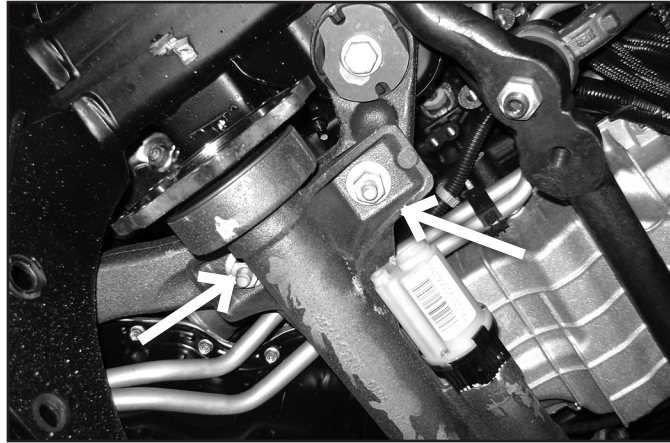


**FIGURE 19B**

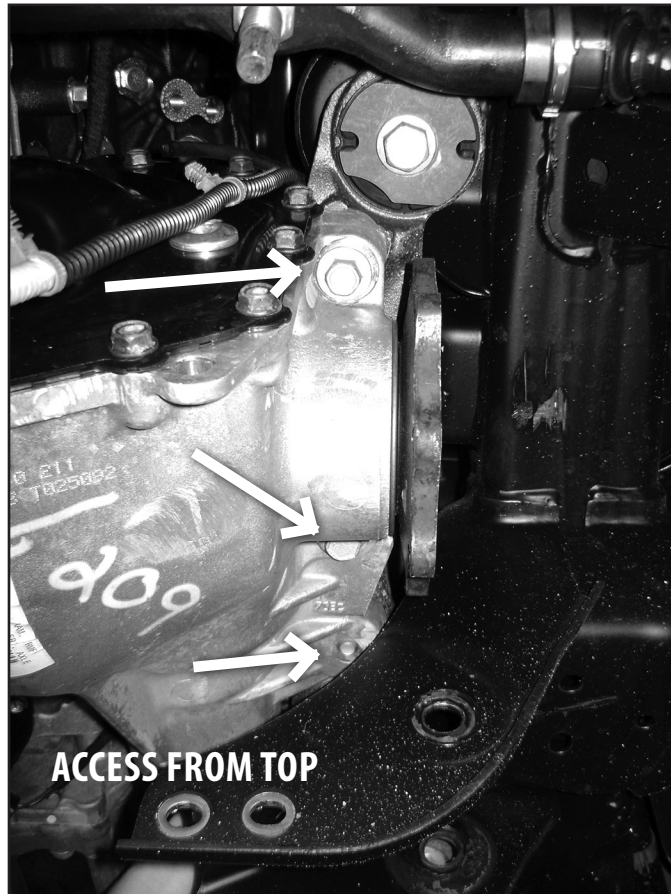


28. Loosen but do not remove all of the front differential mounting bolts/nuts. There are two nuts on the passenger's side (Fig. 20A) and three bolts on the driver's side (Fig 20B - two mount from the bottom up and one from the top down). Remove the rear-most bolt mounting from the top.

**FIGURE 20A**

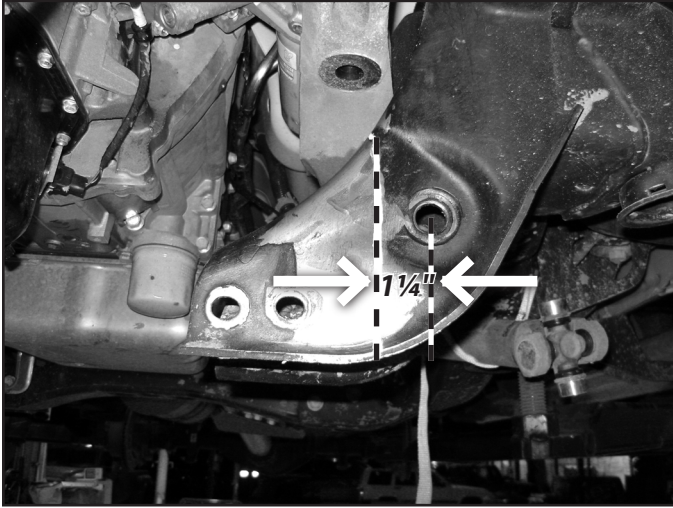


**FIGURE 20B**



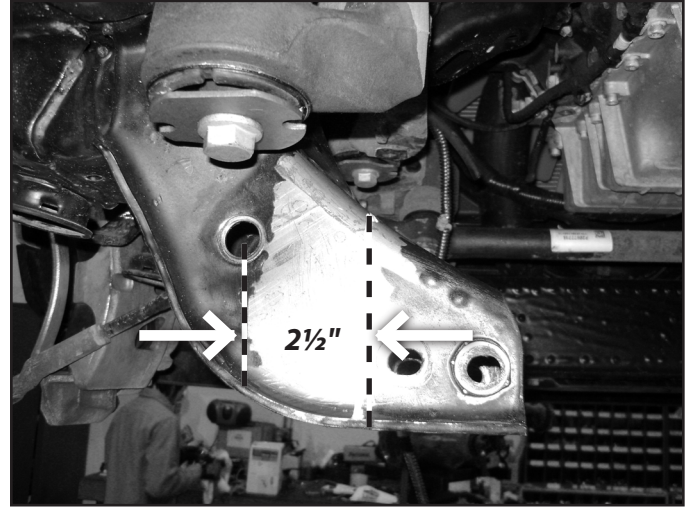
29. Support the front differential with an appropriate jack. Remove the differential mounting hardware and lower the differential from the vehicle and set aside. Save hardware.
30. The lower rear driver's side control arm pocket must be trimmed to provide clearance for the front differential. On the front face measure from the center of the control arm mounting hole inward 1-1/4" and mark (Fig. 21A). On the back face measure from the center of the control arm mounting hole inward 2-1/2" and mark (Fig. 21B). Make vertical cut lines at the marks on the front and back faces. Along the top, connect the front and back cut lines with a diagonal cut line (Fig. 21C).

**FIGURE 21A**



Front Driver Side

**FIGURE 21B**



Rear Driver Side

**FIGURE 21C**



31. Using a reciprocating saw (recommended), cut-off wheel, or plasma cutter, cut the pocket along cut lines. Remove any burrs or rough edges and paint any bare metal to prevent corrosion.

## FRONT INSTALLATION

32. Install the (2) provided large bushings and 0.875" OD x 2.620" long sleeve into the eye of the new center differential bracket (Fig. 22).

**FIGURE 22**



33. Locate the 4 housing bolts to be removed. Remove the four bolts, place the bracket in position and fasten with new 10mm x 40mm bolt and washers (BP #586). The bracket gusset will be toward the bottom of the differential (Fig. 23). Use thread locket on the bolt threads and torque to 59 ft-lbs.

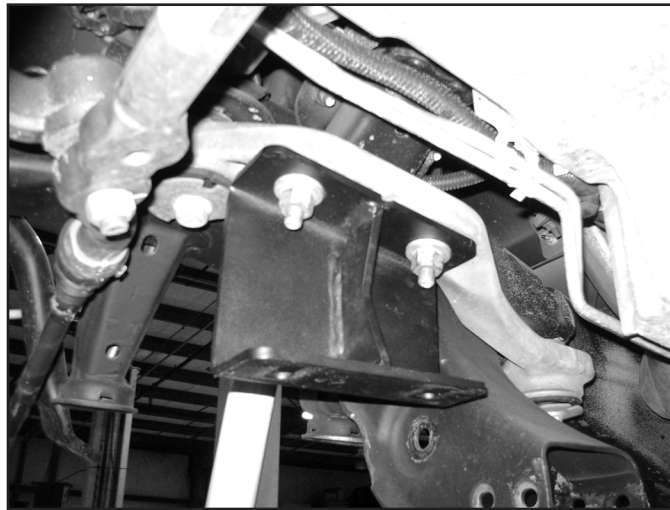
**FIGURE 23**



34. Locate the new passenger's side differential bracket. Bracket has a single center gusset. Install the bracket on the existing studs on the passenger's side factory bracket. Fasten with the original nuts and washers. When installed the open side of the bracket will face inward and the bracket will taper down as it goes to the rear (Fig. 24). Torque nuts to 74 ft-lbs.

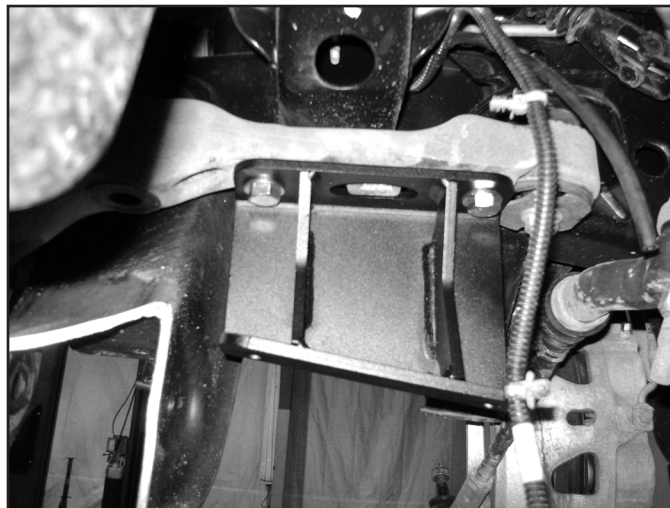


**FIGURE 24**



35. Locate the new driver's side differential bracket. Bracket has two center gussets. Install the bracket to the 2 front original differential mounting holes with the provided 12mm-1.75 x 40mm bolts and 1/2" SAE washers (BP #586), applying thread locker to the threads before installation. When installed the open side of the bracket will face inward and the bracket will taper down as it goes to the rear (Fig. 25). Torque bolts to 65 ft-lbs.

**FIGURE 25**



36. Using an appropriate jack, raise the differential up into the vehicle. Align the differential mounting holes to the new driver's and passenger's side differential brackets. Fasten to the driver's side mount with 1/2" x 3-1/2" bolts, nuts and 1/2" SAE flat washers (BP #586). Fasten the passenger's side 1/2" x 1-1/2" bolts, nuts and heavy 1/2" (large OD) washers. Snug up hardware, but do not tighten (Fig. 26).

*Note: Check clearance between the CV flange mount and the flared surface on the factory rear cross member mount. This area on the frame may need to be clearanced with a grinder if it is too close to the CV flange mount.*

**FIGURE 26**



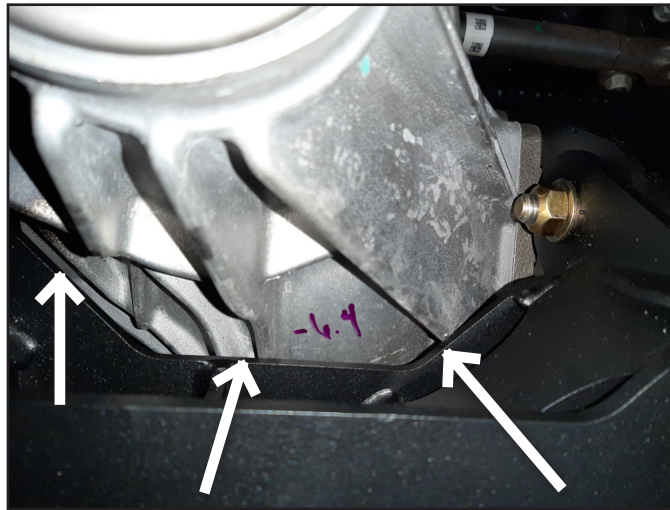
37. Locate the new rear cross member. Install the cross member in the rear lower control arm pockets with the factory control arm bolts/nuts. Run the bolts from rear to front. The center differential bracket will fit into the mount tabs on the cross member. Fasten the differential mount to the cross member with a 9/16" x 4" bolt, nut and 9/16" SAE washers (BP #586). Leave hardware loose (Fig. 27).

**FIGURE 27A**



*Note: OE front differentials have varied in design with and without ribs which may interfere with the replacement rear crossmember, The ribs on the differential may need to be ground down to clear the rear crossmember. See Figure 27B.*

**FIGURE 27B**



38. With the differential and rear cross member installed, tighten all the differential mount hardware. Torque the (4) 1/2" bolts to 65 ft-lbs and (1) 9/16" bolt to 95 ft-lbs.
39. Reconnect the front drive shaft to the front differential with the factory clamps and bolts; lining up the mark made in the previous step. Torque hardware to 25 ft-lbs.
40. Reconnect the front differential actuator wire. Reattach the wire harness to the housing. Use the provided zip ties where needed. Pull down on the differential breather hose to gain slack and reconnect to the top of the differential.
41. Locate the new front cross member. Install the cross member in the front lower control arm pockets and fasten with the original control arm bolts/nuts (Fig. 28). Run the bolt from front to rear. Leave hardware loose.

**FIGURE 28**



## **BUMP STOP RELOCATION INSTALLATION**

42. Locate all of the provided rivet nuts and bump stop relocation bolt pack 871. There are 3 of each of the 2 different rivet nuts sizes are provided, one set is longer than the other. Sort the rivet nuts by size. (Fig 29) Set up the rivet nut installation tools. The 3/8" tool consists of a 3/8" x 1-1/2" bolt, 7/16" hex nut and 3/8" star washer.



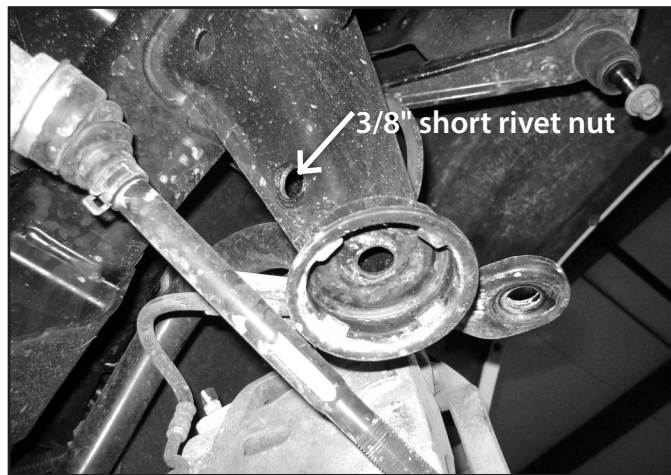
**Tip** For detailed rivet nut installation instructions see the end of this instruction sheet.

**FIGURE 29**

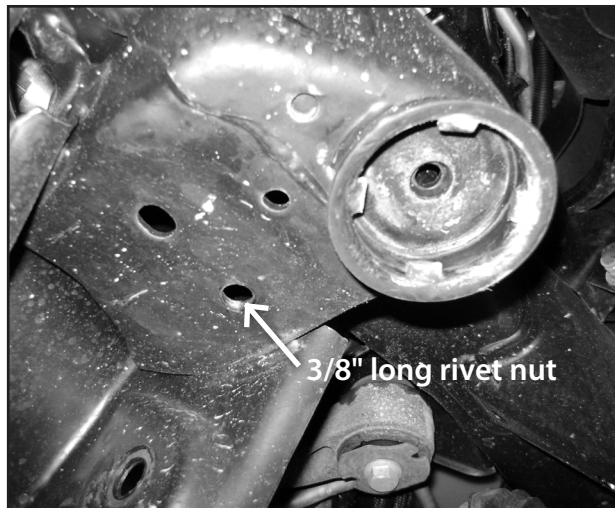


43. Four holes need to be slightly clearanced on the factory bump stop mounts to accepted the rivet nuts. The 3/8" rivet nuts need the holes drilled out to 17/32". If the necessary bits are not available, a rotary grinding tool can be used to enlarge the holes to the proper size. Take care not to open the holes too much. Drill out the holes shown in Figure 30A (front mount) and Figure 23B (rear mount).

**FIGURE 30A**



**FIGURE 30B**

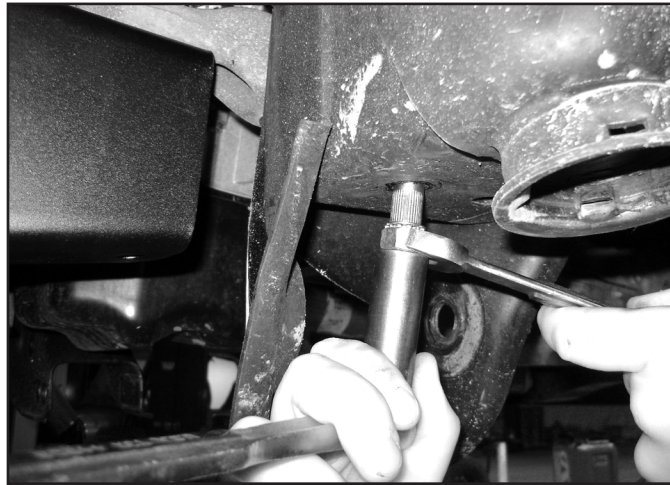


44. Install the rivet nuts. Thread the appropriate rivet nut on the pre-assembled tool. The longer 3/8" rivet nut will be installed in the rear bump stop mount. Insert the rivet nuts into the holes. Hold the jam nut with a wrench and tighten the bolt to collapse the rivet nut in the hole. (Fig 31A) Be sure to hold the rivet nut tight and flush in the hole. Take care not to over tighten. The 3/8" rivet nut can be tighten to approximately 35ft-lbs. Reuse the tool to install all four rivet nuts. (Fig 31B)

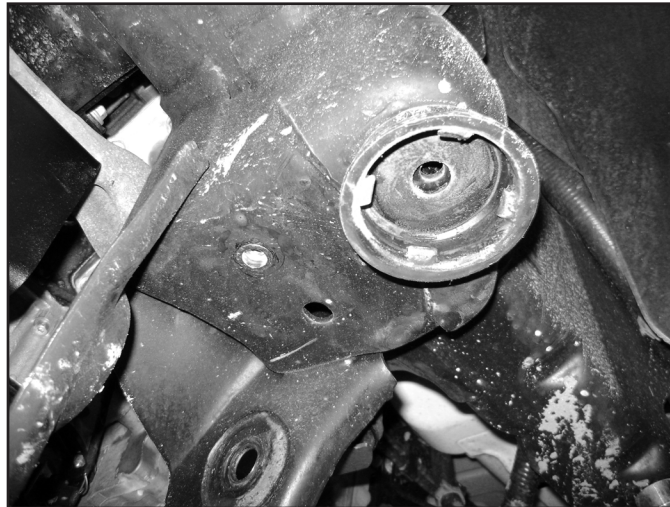


**Tip** For detailed rivet nut installation instructions see the end of this instruction sheet.

**FIGURE 31A**



**FIGURE 31B**



45. With all the rivet nuts installed, locate the provided front bump stop relocation brackets and two nut plates. Install the nut plates in the factory bump stop cups so the tabs point down and lock in place against the tabs in the cup. (Fig 32A) Attach the front relocation brackets to the factory bump stop mount with the nut tab using a 3/8" x 1" Bolt, lock washer, and flat washer from bolt pack 871. Snug up hardware. Fasten the back of the mount with a 3/8" x 1-1/4" bolt, flat washer and lock washer from bolt pack 871. Torque the 3/8" hardware to 30 ft-lbs. (Fig 32B)

**FIGURE 32A**



**FIGURE 32B**



46. Locate the rear bump stop relocation brackets and two nut plates. Install the nut plates in the factory bump stop cups so the tabs point down and lock in place against the tabs in the cup. (Fig 32B) Attach the bump stop relocation bracket to the factory mount with a 3/8" x 1" bolt, flat washer and lock washer into the nut plate. Snug hardware. Push the whole bump stop relocation bracket towards the rear of the vehicle as much as possible. Fasten the back tab of the bracket to the rivet nut with a 3/8" x 1-1/4" bolt, flat and lock washer. Torque 3/8" hardware to 30 ft-lbs.
47. Install the factory bump stops into the new mounts. Place the bump stops in the new cups at an angle and twist them into the cups. (Fig 33)

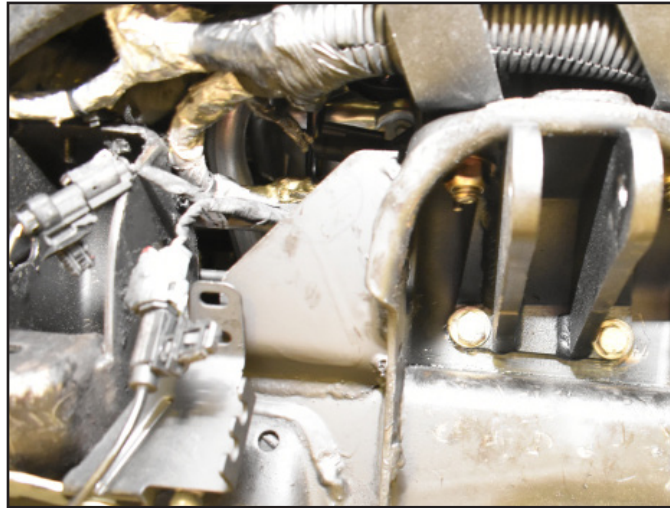
**FIGURE 33**



## CONTROL ARM AND COILOVER INSTALLATION

48. Prep the area by the upper shock mount for welding. Remove the GM undercoating in this area. Using brake clean with a putty knife is the easiest way to remove large chunks of the undercoating.
49. Place the weld-in support plate against the factory brackets. Ensure area is properly prepared for welding. Weld plate with appropriate mig or tig welder, certified welder highly recommended. (Fig 34)

**FIGURE 34**

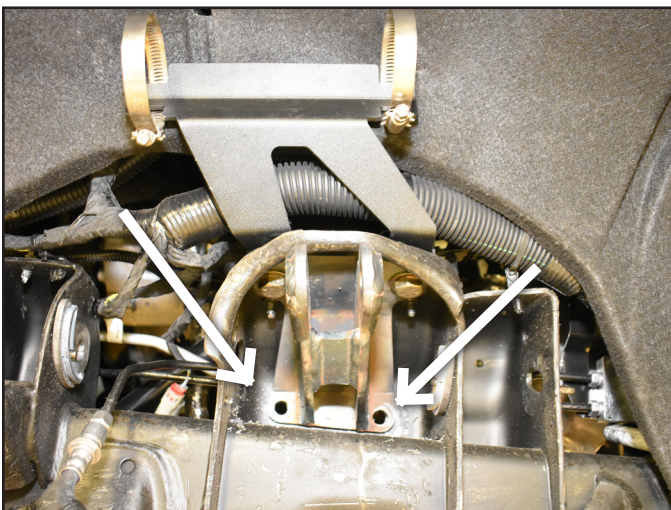


50. Allow plate to cool, coat bare metal with paint.
51. Place the upper coilover bracket against the factory shock mounting bracket using the 1/2" x 1-1/2" bolt and 1/2" hardware in bolt pack 891 to position the bracket. Mark center of the lower two holes and drill out to 1/2". (Fig 35A, 35B)

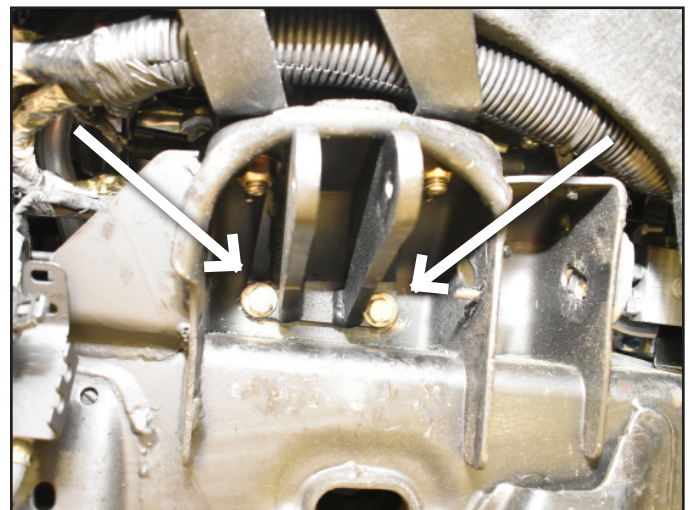


**Tip** Clearance is very tight on the back side of the driver side. Be careful not to drill through any lines on the back side of the OE frame mount.

**FIGURE 35A**



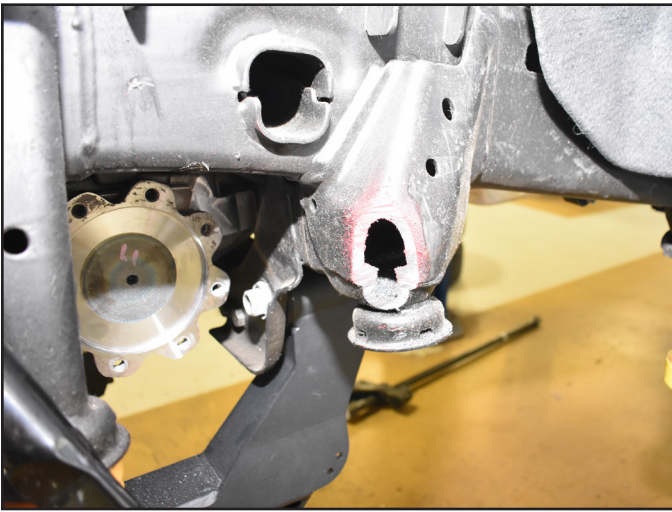
**FIGURE 35B**



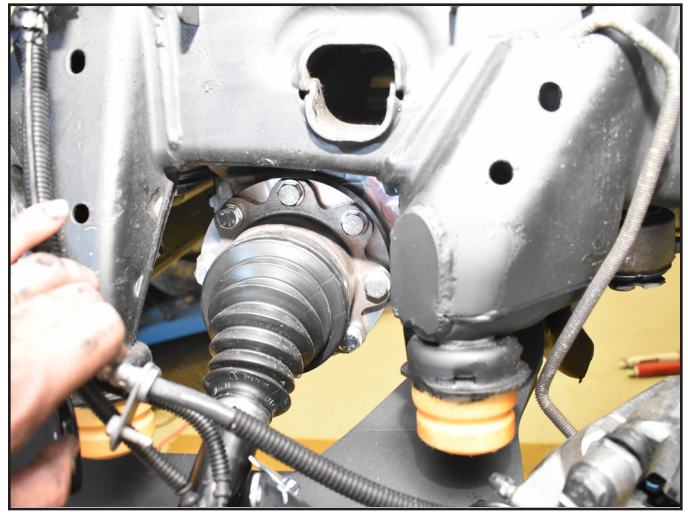
52. Install the upper coilover bracket with 1/2" x 1-1/2" hardware through the original upper mount, attach the reservoir bracket to the top side, as shown in Figure 32A. Leave hardware loose. Attach the two lower holes with 7/16" x 1-1/4" hardware from bolt pack 891. Tighten the 7/16" hardware first to 59 ft-lbs followed by the 1/2" hardware to 90 ft-lbs.
53. Install the upper control arms at this time. Use the factory cam bolts, washers, and nuts. Do not torque to specification at this time. Center the cams and snug hardware.
54. The bump stop mount will need to be cleared for the coilover. This may require a clearance check after the coilover has been installed. Do not weld this clearance plate in until clearance to the coilover has been checked. (Fig 36A & B)

*Note: The coilover will have very tight clearance to this area of the frame. In most cases at full droop the coil spring may touch the frame. This is caused by the coil spring bowing in one direction. The coil spring may need to be rotated to avoid the spring contacting the frame.*

**FIGURE 36A (BEFORE)**



**FIGURE 36B (AFTER)**

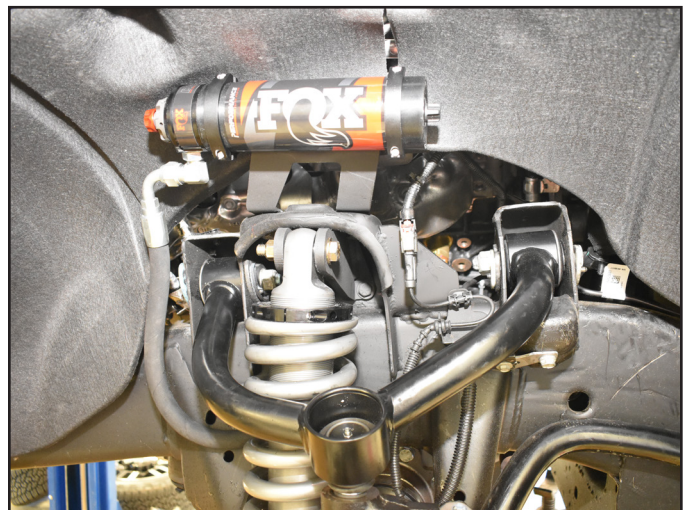


55. Install the coilover at this time with the hose pointed inwards towards the center of the vehicle. The reservoir hose will run out the back towards the rear of the vehicle as shown in Figure 37A. Attach to the upper bracket with 1/2" x 3-1/4" bolt and 1/2" hardware from bolt pack 891.

**FIGURE 37A**



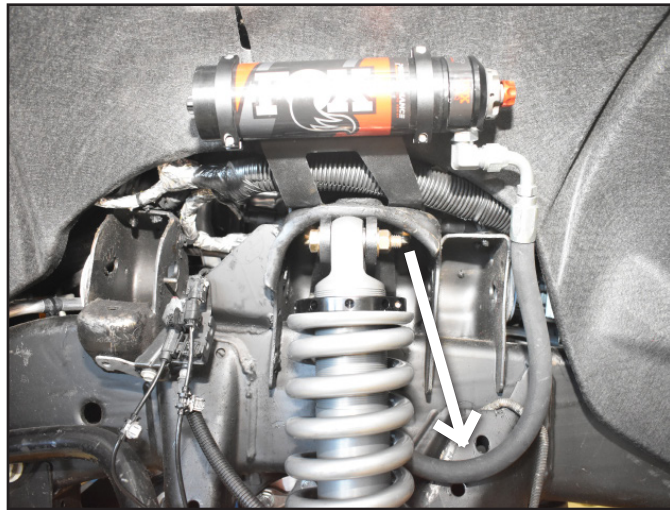
**FIGURE 37B**



56. Route the reservoir hose as shown in Figure 38 and attach the reservoir to the resi bracket with the clamps provided with the reservoirs. Attach the large tube clamp in bolt pack 891 to the reservoir hose so that it sits on the rear OE bump stop bracket. Drill a 17/64" hole where the hole is in the large tube clamp through the OE bump stop bracket. Attach to the frame using the provided 5/16"-18 self threading bolt.



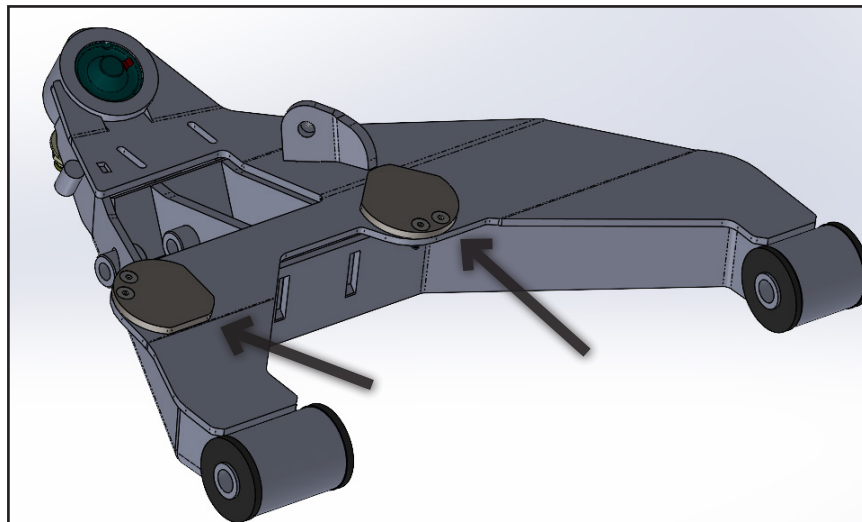
**FIGURE 38**



57. If the desired lift height is 6.5" of lift as intended out of the box, the 1/4" bump stop spacers will need to be installed onto the lower control arm using the flat head screws and hardware from bolt pack BP1041. See Figure 39 for bump stop spacer installation.

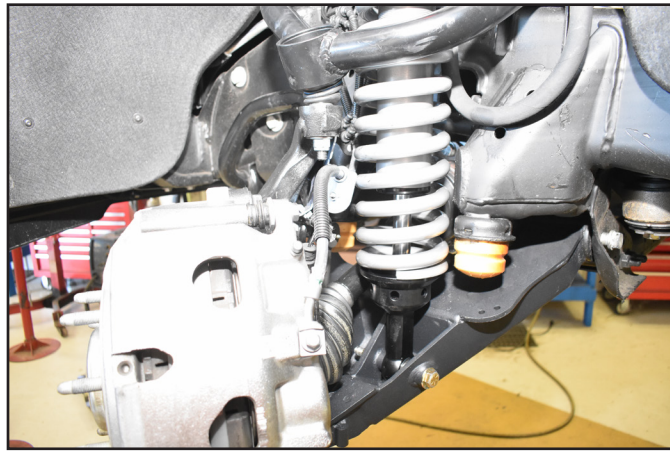
*Note: Do NOT increase preload over 6.5" of lift. If desired the ride height is less than 6" of lift and preload is removed from the coilover, the 1/4" bump stop spacers can be removed. A max of 1" of spring preload can be removed from the coilover to net a ride height around 5" of lift.*

**FIGURE 39**



58. Install new lower control arms with 18mm hardware into the crossmembers using bolt pack 585. Do not tighten the hardware at this time.
59. Attach the lower control arm to the lower coilover mount with 1/2" x 5" bolt and 1/2" hardware from bolt pack 891. (Fig 40)

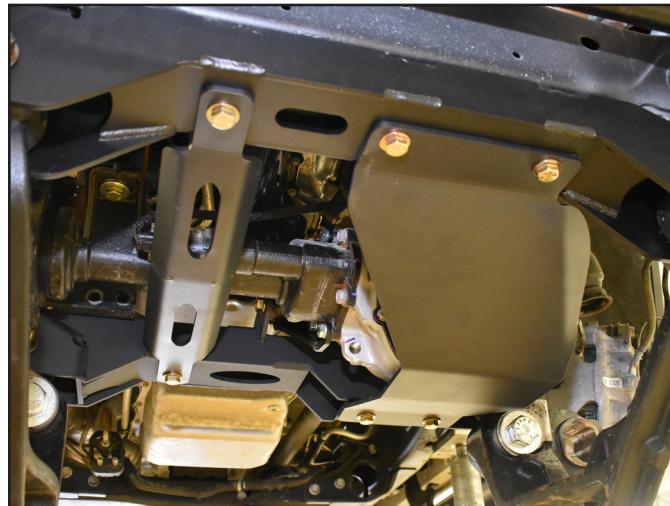
**FIGURE 40**



## **DIFFERENTIAL SKID PLATES**

60. Locate the new differential skid plate. Position the skid plate so that it aligns to holes with the welded nuts on the bottom driver's side of the rear cross member (Fig. 41). Fasten the skid plate with 1/2" x 1-1/4" bolts and 1/2" SAE washers (BP #586). Snug hardware so the front of the skid plate sets up near the bottom of the front cross member.
61. Locate the new cross member support brace (02373). The brace is formed to clear the differential actuator when installed. Position the support brace so it sets properly against the bottom of the front and rear cross members and aligned to the mounting holes. Fasten the tube to the rear cross member with a 1/2" x 1-1/4" bolt and 1/2" SAE washer (BP #586). Again, snug hardware so the brace sets up near the bottom of the front cross member (Fig. 41).

**FIGURE 41**



62. Locate the new front skid plate/splash guard. Loosely attach the skid plate to the original splash guard mounting holes on the upper frame cross member using the original splash guard bolts. (Fig. 42) Position the skid plate up to the bottom of the front cross member "sandwiching" the support brace and differential skid plate. Fasten the front skid plate, differential skid plate and support tube to the front cross member with 1/2" x 1-1/4" bolts and 1/2" SAE washers (BP #586) in the welded nuts in the cross member (Fig 34). Apply Thread locker to the bolt threads and torque to 55 ft-lbs.
63. Rivet on the BDS Badge to the front skid plate / splash guard (Fig 42).

**FIGURE 42**



64. With the front hardware tight, remove the rear bolts one at a time and apply Thread locker to the threads. Reinstall and torque to 55 ft-lbs. Torque the front factory splash guard bolts to 25 ft-lbs.
65. After all the skid plate hardware is tight, go back and torque the 4 factory lower control arm pocket bolts (mounting the new cross members) to 250 ft-lbs.

## **STEERING KNUCKLE INSTALLATION**

66. Locate the new steering knuckles and identify the driver's and passenger's side. Install the appropriate knuckle on the lower control arm and fasten with the original lower ball joint nut. Swing the knuckle up and attach to the upper ball joint with the original nut. Torque the upper ball joint nut to 37 ft-lbs and the lower ball joint nut to 74 ft-lbs (Fig. 43).

**FIGURE 43**



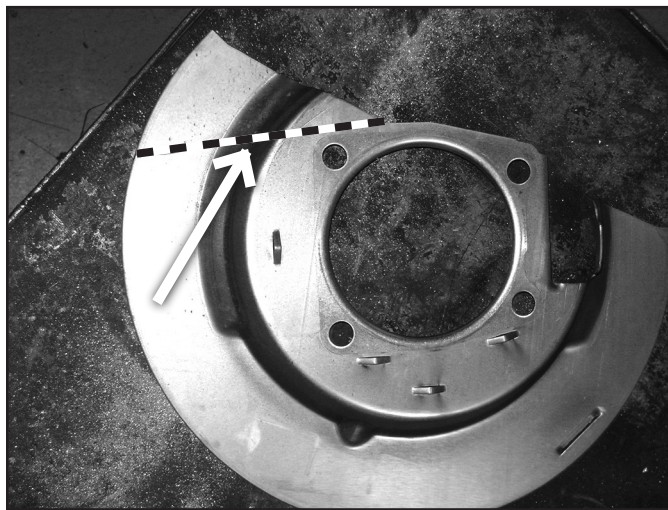
67. Locate the hub o-rings from the factory steering knuckle hub bores. Carefully remove the o-rings if still in the factory knuckle (Fig. 44) and install into the new steering knuckles.

**FIGURE 44**



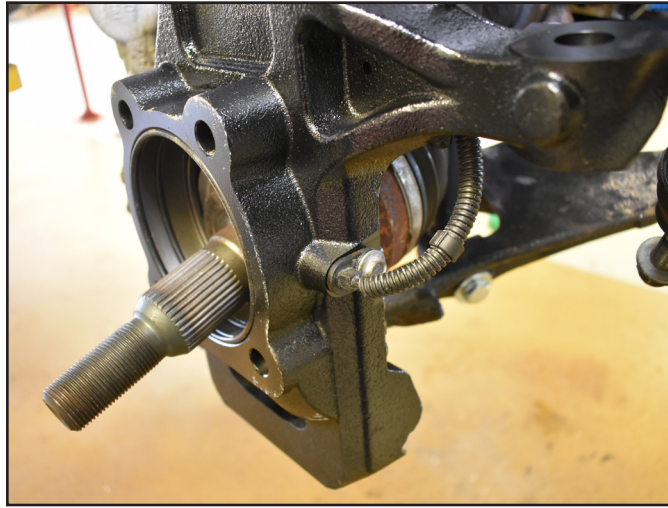
68. Locate the factory driver's and passenger's brake dust shields. They need to be modified to provide adequate brake caliper clearance. Make a cut line by following the straight edge on the caliper side of the shield all the way to the bottom edge of the shield (Fig. 45). Cut the shield along the line.

**FIGURE 45**



69. Install the ABS sensor into the steering knuckle using the factory bolt and thread locker (Fig. 46) Torque to 10 ft-lbs.

**FIGURE 46**



70. Install the hub assembly, O-rings, and dust shield into the appropriate steering knuckle (Fig. 47). Fasten the hub to the knuckle with the factory bolts. Apply thread locker to the threads and torque the bolts to 125 ft-lbs.

**FIGURE 47**



71. Run the ABS line around the back side of the tie rod of the steering knuckle and up to the wire connector on the frame. Reconnect the wire and reattach it to the original place on the frame. Attach the ABS line to the back side of the knuckle near the tie rod end using a wire clamp and a 1/4" x 5/8" bolt, flat washer and lock washer (BP# 877) (Fig. 48).

**FIGURE 48**

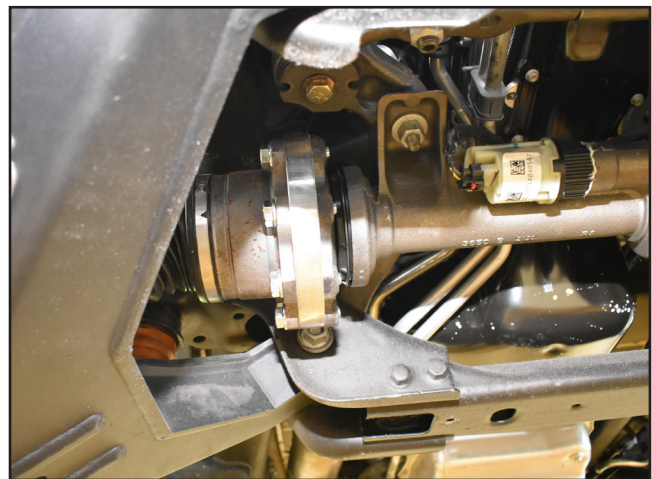


72. Locate the factory CV axle shafts. Install the CV axle into the hub assembly (Fig. 49A) and then onto the differential output flange with the provided CV spacer (Fig. 49B). Align the differential flange holes and fasten with the provided 12mm hardware in bolt pack 890. Apply thread lockers to the threads and torque to 58 ft-lbs.

**FIGURE 49A**

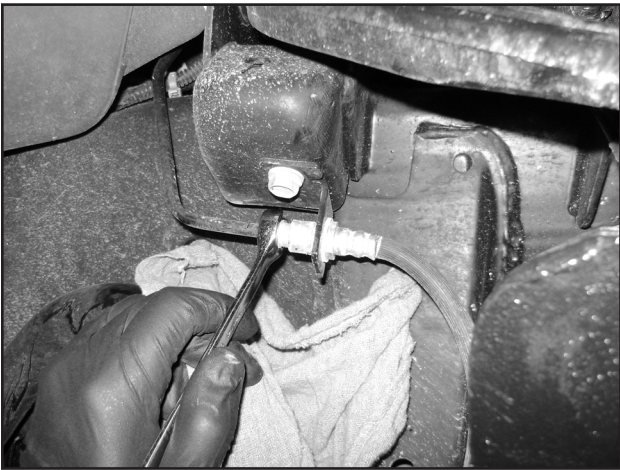


**FIGURE 49B**



73. Install the original CV axle nut and washer and torque to 155 ft-lbs. Reinstall the hub dust cap.
74. Install the brake rotor on the hub by aligning the tapered retainer bolt hole in the rotor with the threaded hole in the hub flange. Fasten the rotor to the hub with the original retainer bolt and tighten securely with a T30 torx bit to 106in-lbs.
75. Locate the factory brake line junction at the frame where the hard line and rubber line meet (Fig. 50A) Using a 13mm line wrench disconnect the hard line from the rubber line. Remove the retaining clip and pull the line from the frame bracket (Fig. 50B). Place a bucket, etc under the hard line to catch any brake fluid drips.

**FIGURE 50A**

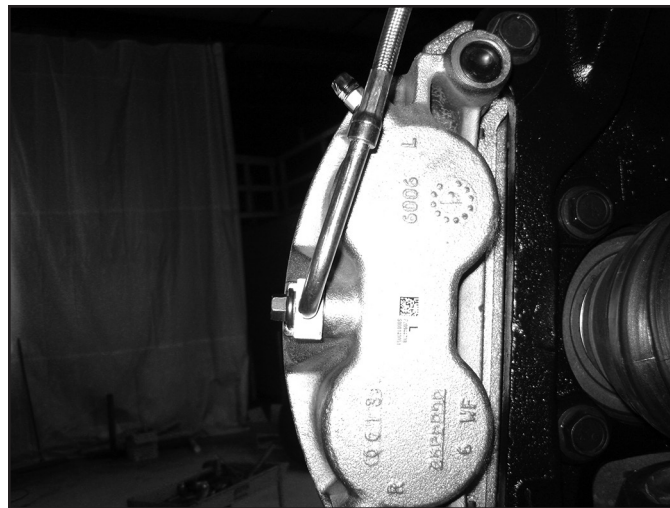


**FIGURE 50B**



76. With the brake lines free, install the brake calipers on the knuckles with the original bolts. Apply thread locker to the bolt threads and torque the bolts to 221 ft-lbs.
77. Locate the new provided stainless steel brake lines. The lines are driver's and passenger's side specific. The caliper end has an offset angle. When install the hard line at the caliper should point slightly inward toward the steering knuckle. Identify the appropriate lines (Fig. 51 - Drv's Side Shown).

**FIGURE 51**



78. Remove the factory brake line from the caliper. Be sure to remove the factory crush washers as well. Place a new provided crush washer on each face of the new brake line and install on the caliper with the factory banjo bolt. Torque the bolt to 25 ft-lbs.
79. Run the new brake line up to the factory frame mount bracket. Feed the end of the line through the bracket and fasten to the factory hard line. Using a 13mm line wrench on the hard line fitting and 11/16" wrench on the new line, tighten the fitting securely. Secure the line to the factory bracket with the original brake line clip or the provided new one (5188) (Fig. 52). When tightening be sure the brake line does not twist. It should run in a smooth arc from the caliper.

**FIGURE 52**



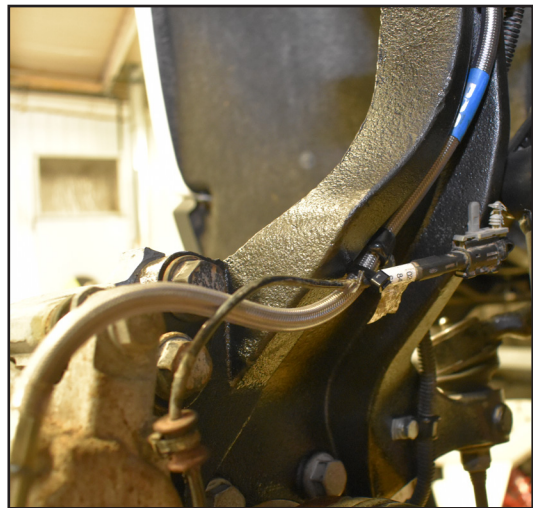
80. There are two threaded holes near the top of the steering knuckle neck on the back side. Using a provided wire clamp, 1/4" x 5/8" bolt, flat washer and lock washer (BP #877) loosely fasten the brake line to the lower threaded hole on the steering knuckle. Using the same fastener combination, attach the ABS line and brake sensor wire to the upper threaded hole. Pull the slack out of the line between the clamp and the caliper to provide as much loose line as possible above the clamp then tighten to lock in place. The hardware will be tightened once the line slack is set (Fig. 53A).

On the back middle of the steering knuckle there is a small threaded hole. Using a wire clamp, fasten the brake line to the knuckle with a 1/4" x 5/8" bolt and hardware (BP #877). (Fig 53B) Pull the slack out of the line between the caliper and the first clamp and tighten the hardware for the clamp to 10 ft-lbs to lock it in place. Continue to pull the slack above the top clamp on the knuckle to have as much loose brake line slack as possible for the suspension motion then tighten the top clamp hardware to 10 ft-lbs to lock it in place.

**FIGURE 53A**



**FIGURE 53B**

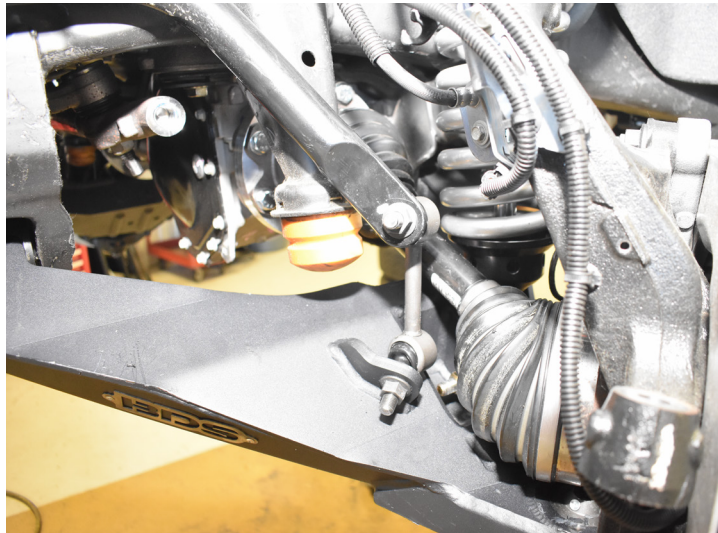


81. Locate the new front sway bar links. Install the sway bar links on the back side of the sway bar towards the CV shaft. This will make sure the joint angles are not overextended.

*Note: Pictured below is the 2-3" coilover sway bar link. The 6.5" sway bar link will be longer, but will install in the same direction as shown in the figure below.*



**FIGURE 54**



## **TIE ROD INSTALLATION**

82. Unthread the inner tie rod from the center steering link.
83. Measure the length of the OE tie rod assembly from the mount face on the inner tie rod to the center of the outer tie rod. Unthread the new HD tie rod assembly to be as close as possible to the OE tie rod assembly length plus one inch. (Fig. 55) Leave jam nut loose.

**FIGURE 55**



84. Apply thread locker to the new HD inner tie rod end. (Fig. 56)

**FIGURE 56**



85. Thread on the new HD inner tie rod end to the center steering link. Tighten to 118 ft-lbs. using provided tool. (Fig. 57)

**FIGURE 57**



86. Apply a small amount of grease to the lip of the rubber boot seal on the outer tie rod to prevent twisting or deforming of the boot.
87. Install the outer tie rod into the steering knuckle using the provided nut. Tighten to 26ft-lbs with the first pass and a final pass of 85-100 degrees. (Fig. 58)

**FIGURE 58**



88. Tighten the jam nut against the outer tie rod. (Fig. 59)

**FIGURE 59**

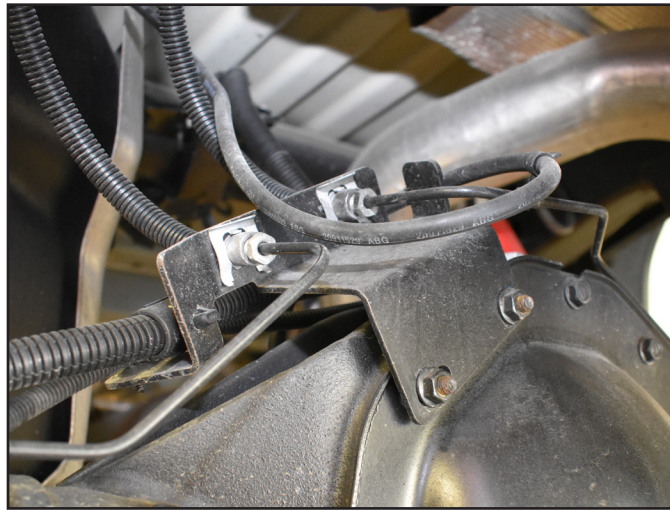


89. Install the front wheels. Torque the lug nuts to 140 ft-lbs. Lower the vehicle to the ground.
90. Bounce the front end to settle the suspension.
91. Torque the lower control arm bolts (4) to 250 ft-lbs.
92. Check all front hardware for proper torque.
93. Properly bleed the entire brake system. Top off fluid. Check all brake lines for proper clearances. Adjust as necessary.
94. Check tire/wheel clearance with the fenders/bumper as well as with the steering knuckle. It is not uncommon to trim the lower plastic valance of the bumper and inner fender shroud slightly to add proper tire clearance while turning.

## **REAR INSTALLATION**

1. Block the front wheels for safety. Raise the rear of the vehicle and support with jack stands under the frame rails, just ahead of the front leaf spring hangers.
2. Remove the wheels.
3. Raise rear of vehicle and support frame with jack stands.
4. Support the rear axle with a hydraulic jack.
5. Disconnect the two nuts attaching the brake lines to the rear differential housing. Save hardware, it will be reinstalled later (Fig. 1).

**FIGURE 1**



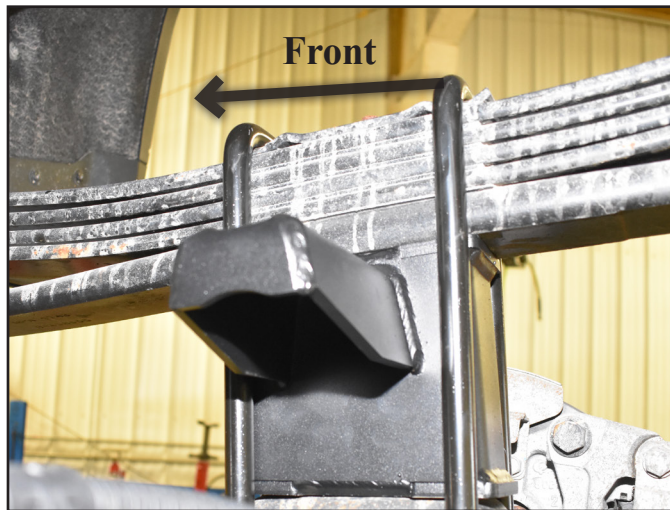
6. Remove the ABS mount from the top of the differential housing. Save hardware, it will be reinstalled later (Fig. 2).

**FIGURE 2**



7. Remove the rear shocks. Save hardware.
8. With the axle well supported, remove the passenger's side u-bolts and lower u-bolt plate. Loosen, but do not remove the u-bolt hardware on the driver's side. This will allow the axle to move more easily and aid in installation.
9. Install the new blocks between the axle and the leaf spring. Position the block so that the bump stop wing faces inward, and the small side of the block faces forward. Align the pins/holes and raise the axle to seat the assembly. The pin will go into the REAR most hole on the block. Install the new provided u-bolts with the factory u-bolt plate (Fig. 3A/ B). Fasten with the provided locking flange nuts. Snug hardware. Final torque will be down with the vehicle on the ground.

**FIGURE 3A**

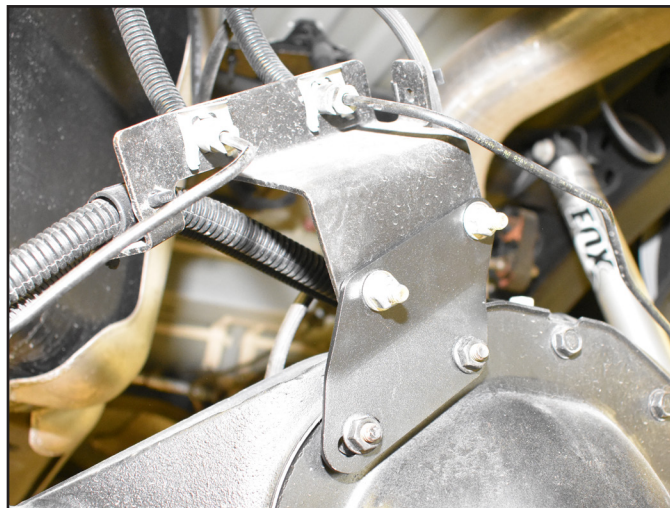


**FIGURE 3B**



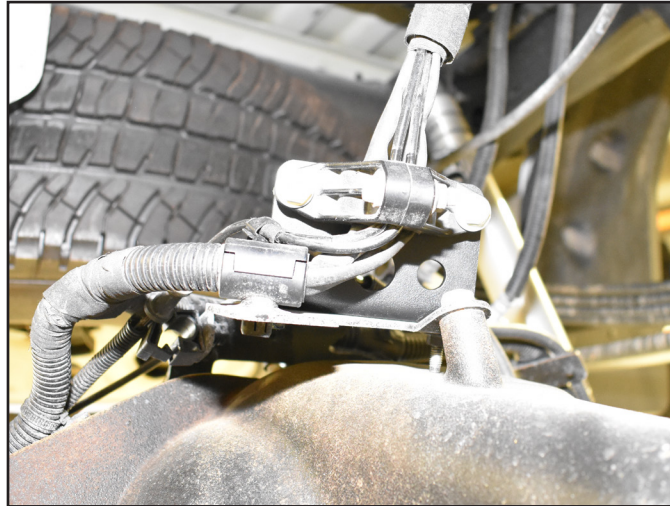
10. Repeat block installation of the driver's side.
11. Install the rear brake line relocation bracket to the differential using the factory hardware. Using the provided 5/16" hardware (BP #873) attach the rear brake line bracket to the relocation bracket (Fig. 4).

**FIGURE 4**



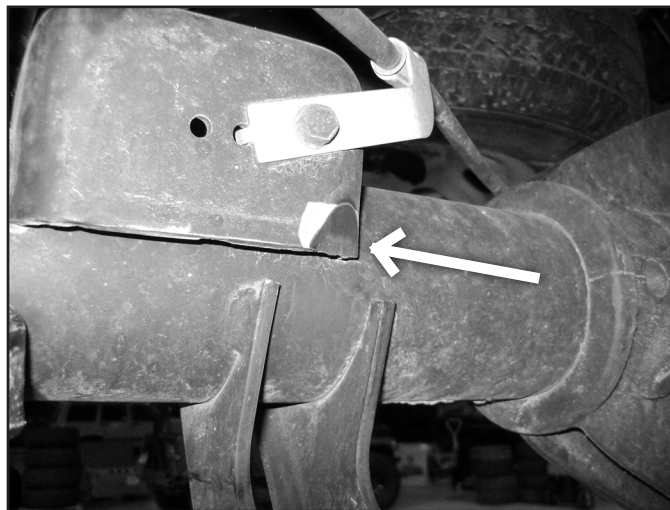
12. Install the rear ABS line relocation bracket to the differential using the factory hardware. Using the provided 1/4" hardware (BP #873) attach the rear brake line bracket to the relocation bracket (Fig. 5). Additional wire clips may need to be undone to add enough slack for the ABS lines, use the zip ties where needed.

**FIGURE 5**



13. The passenger's side bump stop bracket on the axle must be trimmed slightly to add clearance for the new larger rear shocks. Grind the inside front corner to gain approximately 1/4" of clearance (Fig. 6). Paint bare metal to prevent rust.

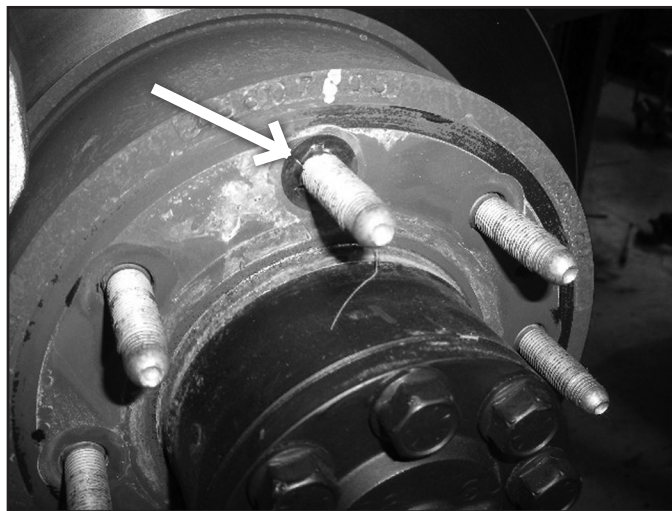
**FIGURE 6**



14. Install new rear shocks with the provided hardware. Fasten the shocks with the factory hardware and torque to 100 ft-lbs.
15. Check all cables for adequate slack at full droop, make adjustments if necessary.

16. Remove clips on wheels (Fig. 7). Reinstall wheels and lower vehicle to the ground. Torque u-bolts to 125 ft-lbs. Torque lug nuts to 140 ft-lbs.

**FIGURE 7**



## FINAL CHECK

17. Check all hardware for proper torque.
18. Reconnect the positive and negative battery cables.
19. The vehicle will need a complete front end alignment.
20. Check all hardware after 500 miles.
21. Adjust headlights.



## WE WANT TO SEE YOUR RIDE!

Grab photos of your BDS-equipped truck in action and send them in for a chance to be featured. Send it in to our Bad Ass Rides customer gallery at [bds-suspension.com/bar](http://bds-suspension.com/bar) and post them on the BDS Fan Page on Facebook at [facebook.com/BDSSuspensions](https://facebook.com/BDSSuspensions). Don't forget about your BDS swag! BDS offers t-shirts, hoodies, decals and more available on the BDS website or through your local BDS distributor.

---

## TIME TO HAVE SOME FUN

### Thank you for choosing BDS Suspension.

For questions, technical support and warranty issues relating to this BDS Suspension product, please contact your distributor/installer before contacting BDS Suspension directly.

# RIVET NUT INSTALLATION INSTRUCTIONS

## RIVET NUT SIZING

1. Verify the correct size rivet nut for the application based on the thickness of material where the rivet nut is to be installed using the following chart.

Part Number	Thread Size	Body Length (in)	Material Thickness (in)		Drill Size (in)
			Min.	Max.	
95105A159	3/8-16	.690	.027	.150	17/32
95105A168	3/8-16	.805	.150	.312	17/32
95105A169	1/2-13	1.150	.063	.200	11/16
95105A170	1/2-13	1.300	.200	.350	11/16

## HOLE PREPARATION

2. Drill hole to appropriate size for rivet nut installation. 1/2" Rivnuts require an 11/16" hole and 3/8" Rivnuts require a 17/32" drill. It is critical that this hole is drilled to the correct size. Remove any burrs that could keep the rivet nut from seating flat against either side of the hole surface.



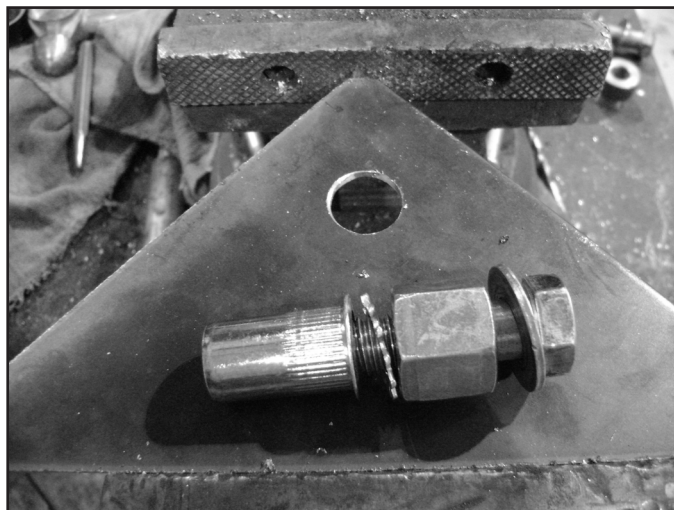
**Tip**

*If the correct drill size is not available, it is possible to drill the hole to an available smaller size and slowly grind it out to until the rivet nut fits tight.*

## RIVET NUT INSTALLATION TOOL ASSEMBLY

3. For a 3/8" rivet nut, place the provided 3/8" SAE flat washer on the 3/8" x 1-1/2" bolt, followed by 7/16" hex nut and then a 3/8" serrated washer. (Fig 1) Thread this tool assembly into the rivet nut.
4. For a 1/2" rivet nut, place the provided 1/2" SAE washer on a 1/2" x 2" bolt followed by a 9/16" high nut and 1/2" serrated edge lock washer. Thread this tool assembly into the rivet nut as shown. (Fig. 1)

**FIGURE 1 - 1/2" RIVET NUT SHOWN**



## RIVET NUT INSTALLATION

5. Place the installation tool with the rivet nut threaded on the end into the appropriately sized hole.



- For a 3/8" rivet nut, hold the nut closest to the rivet nut still with an 5/8" wrench and tighten the 3/8" bolt with a 9/16 wrench to set the rivet nut. Be sure to hold the rivet nut flush to the surface and square to the hole as it is tightened. (Fig. 2)



**Tip** If available, an impact gun is recommended for tightening the bolt to ensure the rivet nut remains square to the hole and to ease holding the nut from spinning.

- For a 1/2" rivet nut, hold the nut closest to the rivet nut still with an 7/8" wrench and tighten the 1/2" bolt with a 3/4" wrench to set the rivet nut. Be sure to hold the rivet nut flush to the surface and square to the hole as it is tightened. (Fig. 2)

**FIGURE 2 - 1/2" RIVET NUT SHOWN**



## TORQUE SPECIFICATIONS

- 3/8" rivet nuts will approach 40 ft. lbs for maximum grip strength. Do not exceed 45 ft-lbs when setting the rivet nut.
- 1/2" rivet nuts will approach 90 ft lbs for maximum grip strength. Do not exceed 100 ft-lbs when setting the rivet nut.



**Tip** If using the recommended impact gun, use caution to not exceed the recommended torque specifications.

## RIVET NUT TOOL REMOVAL

- Once the center bolt is tightened, remain holding the nut from spinning with the wrench and loosen the center bolt to remove the installation tool.



**Caution** It is very important to hold the nut as the bolt is loosened because the grip of the star washer will try to spin the rivet nut and ruin the installation.

- Verify proper installation by checking for consistent rivet nut deformation to see the threads are square and centered to the rivet nut. (Fig. 3)

**FIGURE 3**

