

ARB TOYOTA 80 SERIES REAR STEP TOW BAR

Product number: 5611210

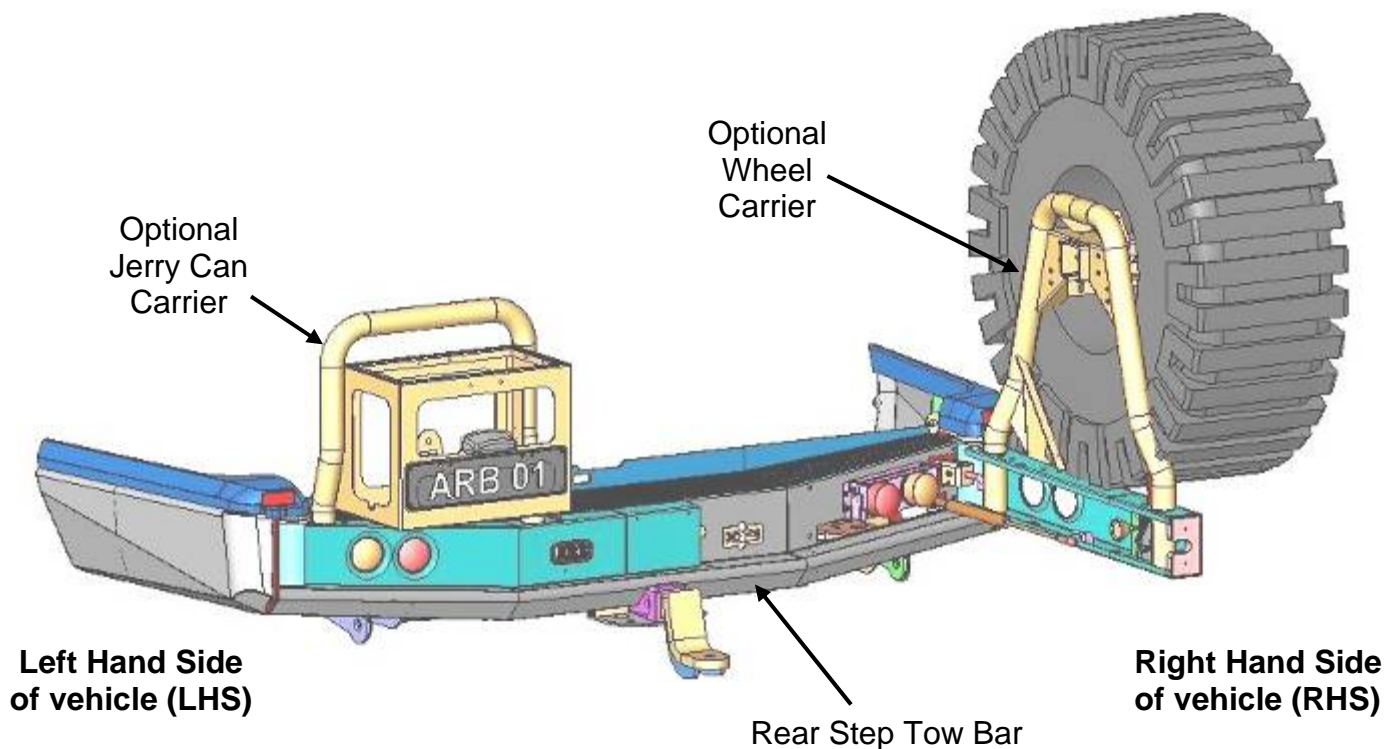

**READ FITTING INSTRUCTIONS
CAREFULLY BEFORE PROCEEDING**

USE	PART No	QTY	DESCRIPTION
FIT TAIL LIGHT ASSEMBLIES TO REAR BAR	6821172L	1	Tail Light Assembly – Left Hand Side (LHS)
	6821172R	1	Tail Light Assembly – RHS
	6151017	12	Bolt M6 x 16
	6151128	8	Nut M6 flange
	6151300	4	Nut M6 cage
	6151046	12	Washer 6mm flat
	3756681	2	Light mount cover bracket
FIT CAGE NUTS TO REAR BAR	6151300	16	Nut M6 cage
	6151303	4	Nut M8 cage
FIT LOCKING PIN BRACKETS TO REAR BAR	3756701	2	Locking pin bracket
	6151022	4	Bolt M8 x 25
	6151132	4	Nut M8 flange
	4581044	4	Washer 8mm flat
FIT LOOM TO VEHICLE	6821163	1	Loom
FIT BAR TO REAR CROSS MEMBER	6151096	2	Bolt M12 x 40 x 1.25
	4581049	4	Washer 12mm flat
	4581050	4	Washer 12mm spring
	3199773	2	Cross member nut plate
	6151306	2	Nut M12 cage
	6151255	2	Bolt M12 x 40 x 1.75
FIT BAR TO UNDERSIDE OF CHASSIS	6151097	4	Bolt M12 x 50 x 1.25
	6151340	2	Bolt M12 x 50 x 1.75
	4581007	6	Washer ½" flat heavy duty gold zinc
	4581050	6	Washer 12mm spring
	5848309	2	Chassis packer front
	5848310	2	Chassis packer rear
	3199772	1	Chassis lower nut plate
	6151306	2	Nut M12 cage
FIT BAR TO CHASSIS SIDE	6151255	4	Bolt M12 x 40 x 1.75
	4581007	4	Washer ½" flat heavy duty gold zinc
	4581050	4	Washer 12mm spring
	3199771	2	Chassis side nut plate
	6151306	4	Nut M12 cage
FIT CENTRE COVER PANEL	6522646	1	Centre cover panel
	6151300	2	Nut M6 cage
	6151352	2	Socket head cap screw M6 x 25 stainless steel
	6151207	2	Bolt M6 x 25
	6151046	4	Washer 6mm flat
	6151042	4	Washer 6mm spring
	5848302	2	Packer black nylon
	6250003	2	Spacer 8mm thick gold zinc

FIT END SURROUNDS TO REAR BAR	3131192L	1	End surround LHS
	3131192R	1	End surround RHS
	6151083	6	Bolt M8 x 35
	6151132	6	Nut M8 flange
	4581044	6	Washer 8mm flat
	6250003	6	Spacer 8mm thick gold zinc
FIT END SURROUND BRACES	3756757L	1	End surround brace LHS
	3756757R	1	End surround brace RHS
	6151017	2	Bolt M6 x 20
	6151046	2	Washer Flat M6
	6151128	2	Nut Flange M6
	6151083	4	Bolt M8 x 35
	6151021	4	Bolt M8 x 20
	6151132	4	Nut M8 flange
	4581044	8	Washer 8mm flat
	4581046	8	Washer 8mm spring
	3199774	1	Wing brace nut plate
6151303	2	Nut M8 cage	
FIT URETHANE TRIMS	3162478L	1	Vertical trim
	3162478R	1	Vertical trim
	3162482L	1	End surround trim
	3162482R	1	End surround trim
	6821166	2	Reflector
	6151162	10	Nut M6 nyloc
	4581082	10	Washer 6mm flat heavy duty black zinc
FIT TOP INFILL PLATE	3199769	1	Top infill plate
	3199727	1	Aluminium step plate
	4590019	1	Rubber extrusion seal
	6151256	10	Button head cap screw M6 x 16 stainless steel
FIT GOOSENECK	4761132	1	Gooseneck
	55010	1	Pull pin
	55020	1	Spring Clip
FIT TRAILER PLUG	6151370	2	Screw M4 x 20 plastite pan head

PARTS SUPPLIED WITH THIS KIT TO BE USED WHEN FITTING WHEEL CARRIERS OR JERRY CAN CARRIERS

FITTING NUMBER PLATE LIGHT	86060BL	1	Number plate light
	6151281	2	Screw M5 pan head
	6151282	2	Nut M5 flange
FIT CENTRE LOCATOR	3756677	1	Centre locator bracket
	6151255	2	Bolt M12 x 40 x 1.75
	4581049	4	Washer 12mm flat
	4581050	2	Washer 12mm spring
	6151189	2	Nut M12 x 1.75

TOOLS REQUIRED: Basic tool kit, 30mm socket, ¼" drive socket set, silicon.

TORQUE SETTINGS: 6mm – 9Nm, 8mm – 22Nm, 10mm – 44Nm, 12mm – 77Nm

FITTING TAIL LIGHTS TO BAR

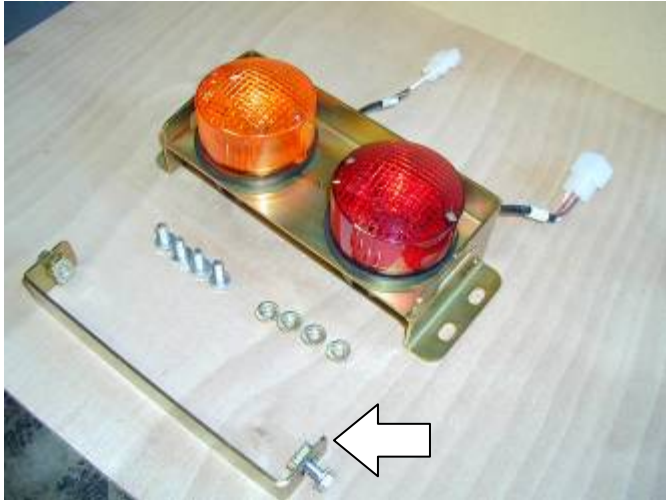

1. Compile components as shown.
 - Light assembly (LHS shown)
 - Light cover
 - 6 x M6 x 16mm bolts
 - 6 x M6 flange nuts
 - 2x M6 cage nuts
 - 6 washers to suit M6
2. Fit cage nuts to light cover as shown.

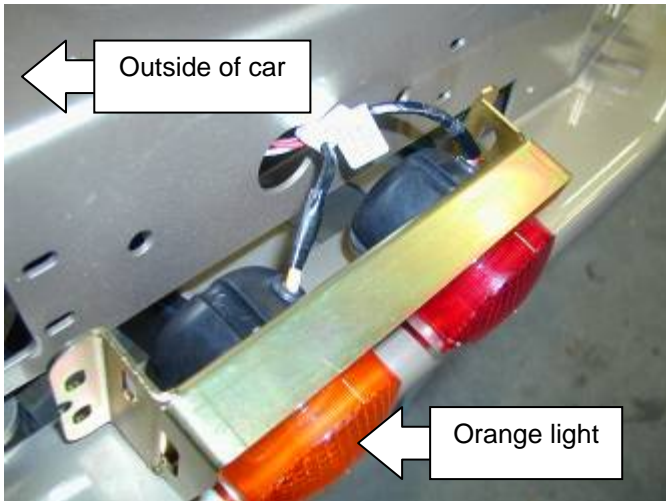

When fitting light assemblies to bar, orange (indicator) lights must be to the outside as shown. The flange on the bracket should also be at the top.

3. Feed looms through large hole in bar.



4. Fit light assemblies using M6 hardware. Finger tighten only.
5. Repeat steps 1 to 3 for RHS assembly.



6. Fit M6 cage nuts to light mount cover bracket as shown.

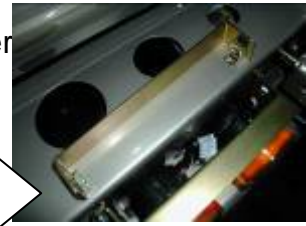

7. Using **M6 x 16 bolts** and flat washers, fit cover bracket to light mount.

8. Tighten only cover bracket bolts securely.

FITTING CAGE NUTS TO BAR



9. Fit M6 cage nuts (9 total) in square holes in top of bar as shown.

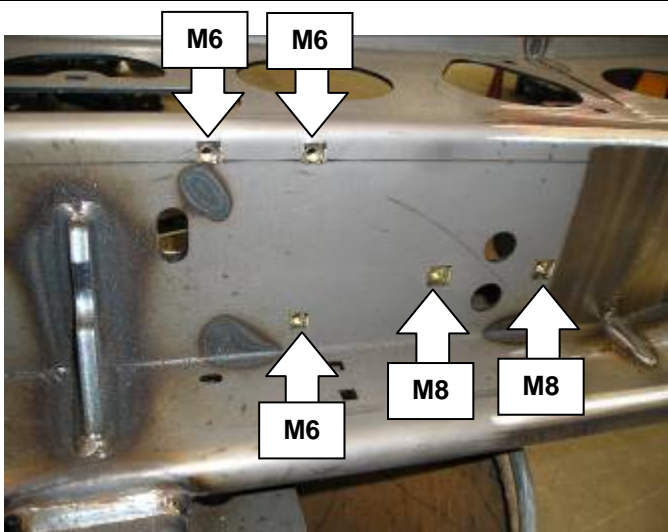

10. Fit M6 cage nuts (6 total) and M8 cage nuts (4 total) to front of bar. (RHS shown)

FITTING LOCKING PIN BRACKETS TO BAR

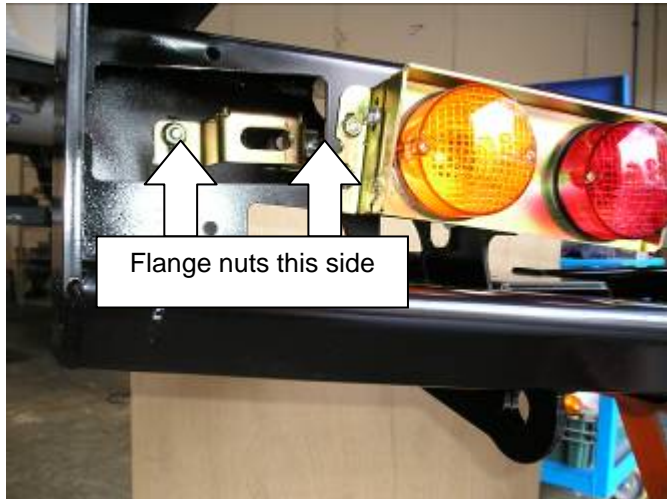

11. Fit locking pin brackets using two **M8 x 25 bolts**, flat washers and flange nuts. Finger tighten only.

Fit bolts through from rear of rear bar so that the flange nuts are on the same side as the bracket as the photo shows.

(Viewed from front of bar LHS.)

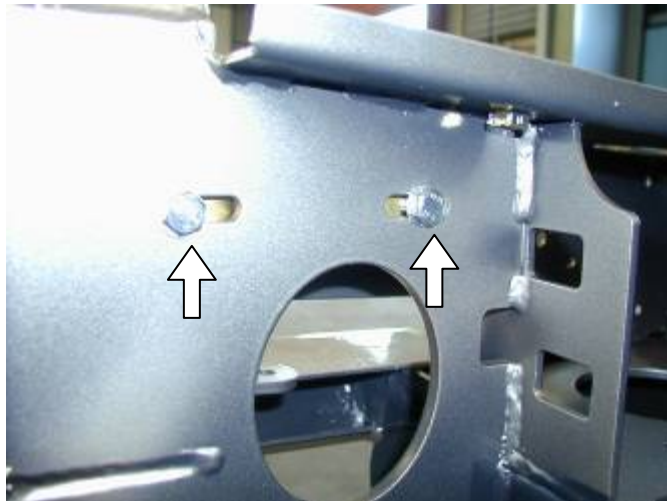

12. M8 bolts must fit in rear of bar for ease of adjustment later on.

(Viewed from rear of bar LHS.)

REMOVING BUMPER



13. To fit Rear Bar to vehicle, remove bumper bar, mud flap and tow bar (if fitted) from vehicle.

OPTIONAL

Paint lower rear quarter panel satin black.

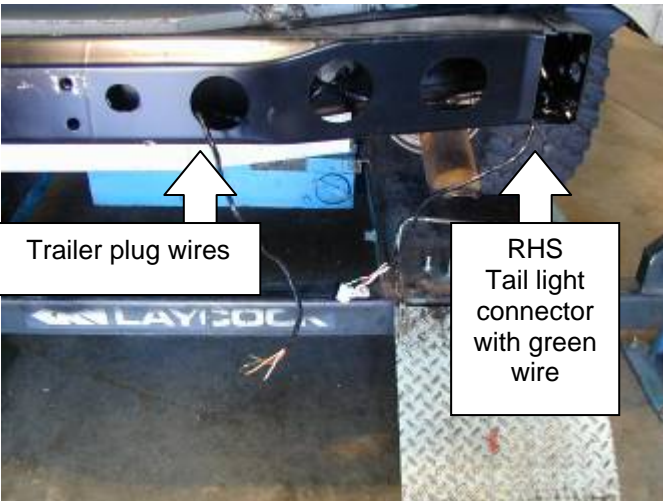
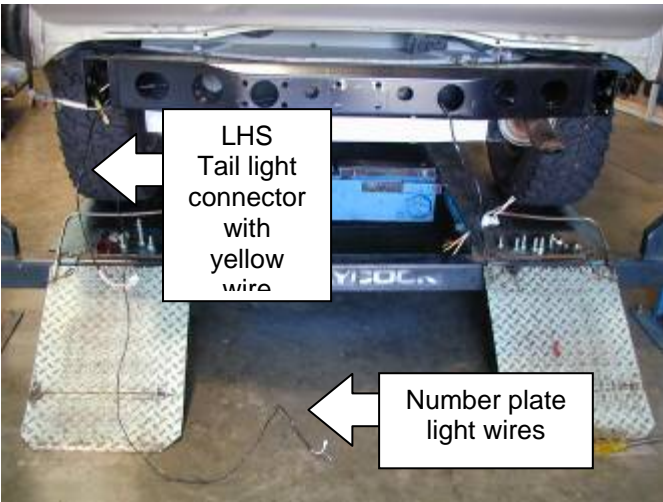

FITTING LOOM TO VEHICLE

	<p>14. Fit loom inside rear cross member of vehicle chassis.</p> <p>The plug for connecting the loom to the vehicle must be on the RHS of the vehicle.</p>
	<p>15. Exit tail light wires and trailer plug wires as shown.</p> <p>The tail light connectors with the GREEN wire must be on the RHS of the vehicle.</p> <p>The tail light connectors with the YELLOW wire must be on the LHS of the vehicle.</p>
	<p>16. The loom is fitted with wiring for a number plate light.</p> <p>If a jerry can carrier is to be fitted the number plate and light should be fitted to it. The wire for the number plate light must be on the same side of the vehicle as the jerry can carrier.</p> <p>If a wheel carrier is to be fitted without a jerry can carrier the wire for the number plate light should be on the same side of the vehicle as the wheel carrier.</p>



17. Make sure when plug is connected to vehicle that wire is cable tied well clear of muffler and exhaust components that may melt it.



18. If a wheel carrier or jerry can carrier is not to be fitted a cover panel must be fitted.

If cover panels are to be fitted they must be fitted to the bar before it is fitted to the vehicle.

Refer to fitting instructions supplied in cover panel fitting kit for fitment of cover panel.

FITTING REAR BAR TO VEHICLE



19. Fit 8mm cage nuts to wing brace nut plate and insert into LHS of vehicle and align with rear holes in side of chassis



20. With the help of a friend to hold the previously fitted nut plate in the correct position, fit the LHS end surround brace to the side of the chassis rail using M8 x 35mm bolts, spring washer and flat washer., finger tighten only.



21. Whilst working on the LHS, fit M12 x 1.75 caged nuts into side plates, and fit plate as to press wing brace nut plate arm against the inside of the chassis rail to stop any rattling when the rear bar is fitted to vehicle.

NB FIT CAGE NUTS TO SIDE PLATES SO PLATES ARE HANDED.



22. Fit **M12 x 1.75 cage nuts** to chassis side plates and insert into end of chassis rails.

NOTE:

After bar is fitted and bolts are tightened in these chassis side plates, the handles must be bend over so that struts are not damaged when wheel carriers or jerry can carriers are closed.

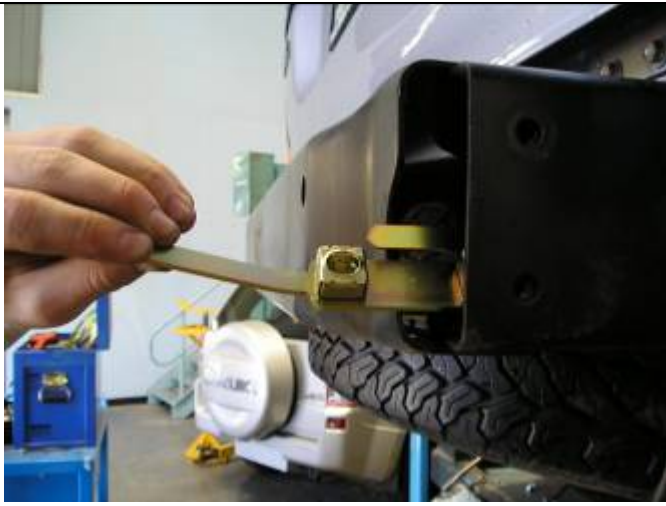

23. Fit 2 x M12 x 1.75 cage nuts into plate and insert into inside RHS chassis rail and align with underside of chassis holes.
24. Bend rear handle of nut plate to enable plate to fit flat on the inside of chassis rail.

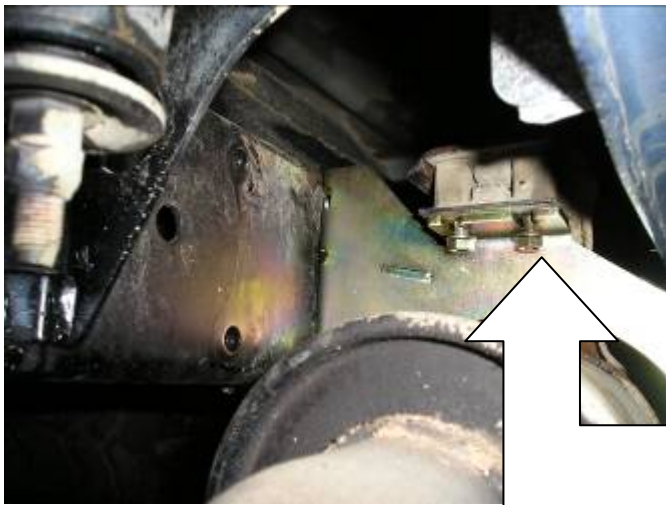

25. On RHS of vehicle remove exhaust hanger bracket from vehicle and remove rubber isolater body from muffler for ease of fitment later.
26. Using M8 x 35mm bolts, spring washers and flat washers, secure side surround brace to rear holes in side of chassis rails.
27. Refit rubber isolater body back to muffler and to the side surround brace.

FINGER TIGHTEN ONLY



28. Fit M12 x 1.75 cage nut into rear cross member nut plate and fit to both sides of rear cross member.

PHOTO IS LHS OF VEHICLE

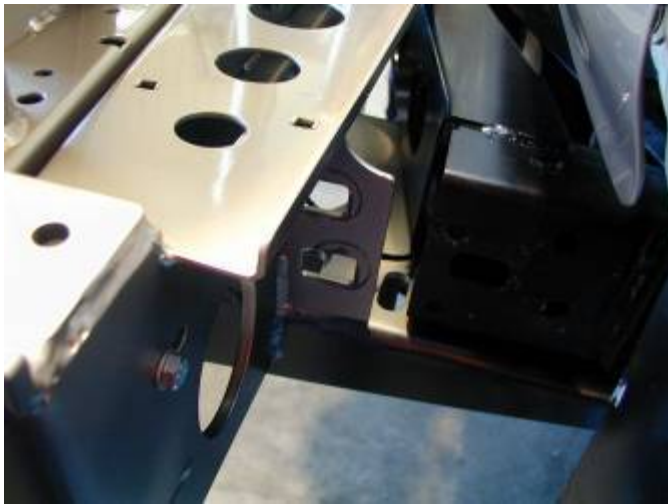

29. Slide bar onto rear of chassis leaving enough room to plug main loom into tail light assemblies on either side of vehicle.
30. When this is done push bar onto chassis until centre mount of bar is flush up against chassis cross member.



31. Fit two **M12 x 40 x 1.25 bolts**, spring washers and flat washers as shown into centre mounting bracket.
(Finger tighten only.)

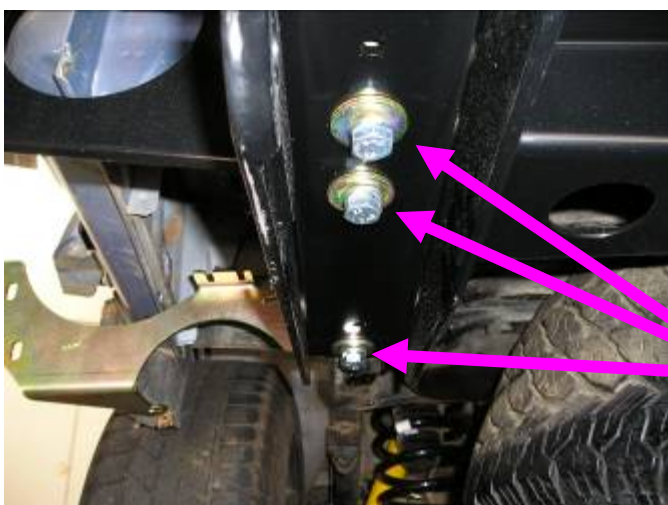

32. Fit 3 x **M12 x 40mm x 1.25 (fine thread) bolts**, spring washers and large gold colored flat washers to underside of chassis rails to LHS of vehicle
(Finger tighten only.)

**M12 X 1.25 X 50 BOLTS
(FINE THREAD)**

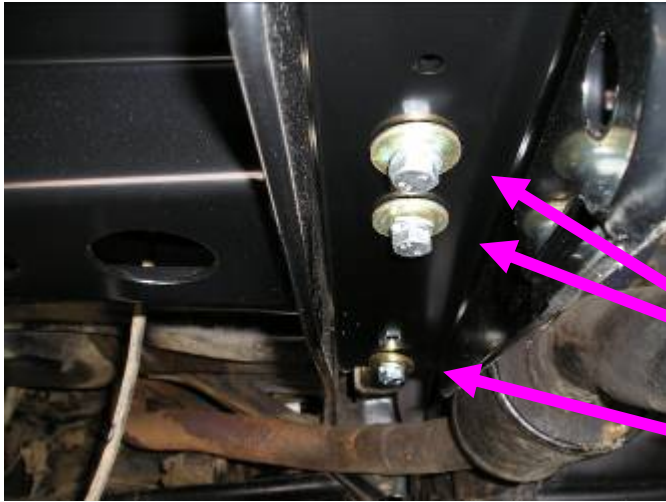

To the RHS of the vehicle, fit 2 x M12 x 1.75 x 50 (coarse thread) bolts, spring washer and flat large gold coloured washer to the most forward hole. To the rear hole, fit 1 x M12 x 1.25 x50 bolt, spring washer and flat large gold coloured washer

M12 X 1.75 X 50 BOLTS

M12 X 50 X 1.25 BOLT

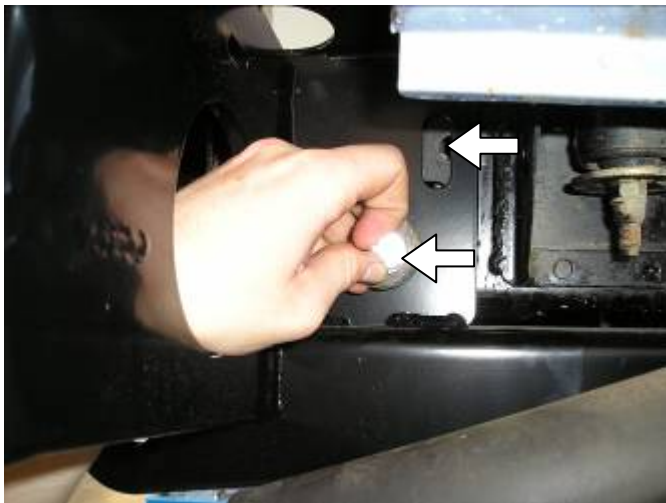

33. Fit two **M12 x 40 x 1.75 bolts**, large gold coloured flat washers and spring washers into captive nut plates (installed previously step17) on each side of vehicle.
(Finger tighten only)

Align nut plates using handle that protrudes through cut out in rear of bar.

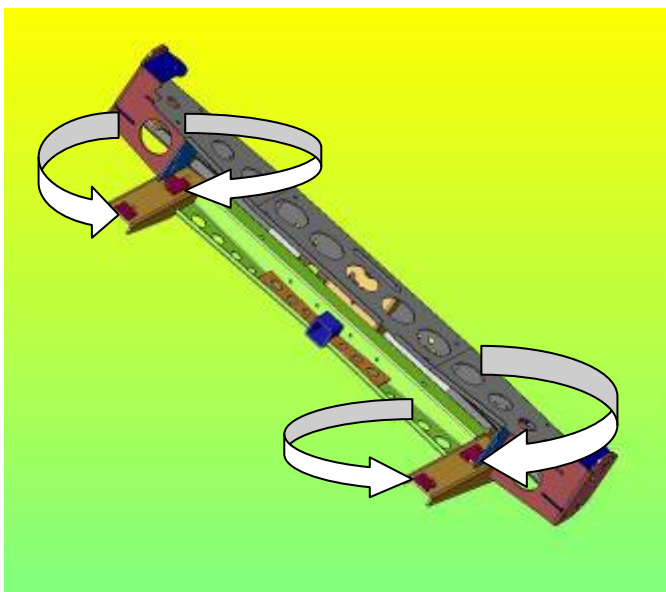

34. Before tightening any bolts you must fit the 8mm packers in between the rear bar and the vehicle chassis. The double cut out packers to the rear of the bar, and the single cut out packers to the front of the bar. When these packers are fitted, tighten all bolts firmly.

ARROWS INDICATE WHERE PACKERS ARE TO BE FITTED



35. . The single cut out packers to the front of the bar. (As viewed from front of vehicle) When these packers are fitted, tighten all bolts firmly.

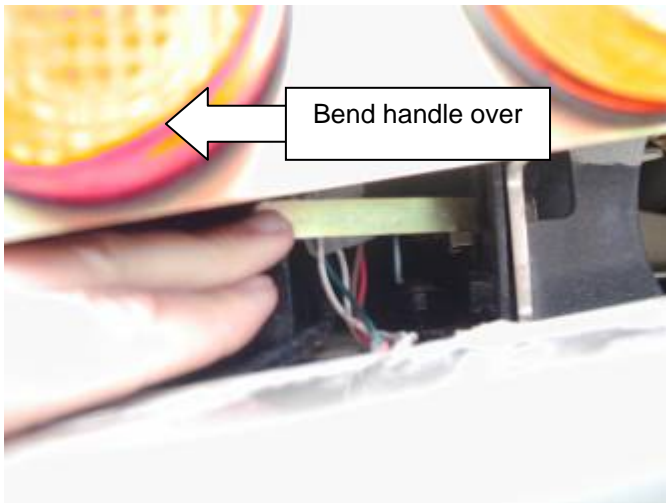

36.

Bend over handles of nut plates so that struts are not destroyed when wheel carriers or jerry can carriers are closed.

AT THIS STAGE JERRY CAN CARRIERS OR WHEEL CARRIERS MUST BE FITTED.

TO FIT JERRY CAN CARRIERS AND WHEEL CARRIERS, REFER TO FITTING INSTRUCTIONS SUPPLIED IN FITTING KITS WITH JERRY CAN CARRIERS OR WHEEL CARRIERS.

IF A JERRY CAN CARRIER OR WHEEL CARRIER IS NOT TO BE FITTED, THE COVER PANEL SHOULD BE ALREADY FITTED. (REFER TO STEP 16.)

FITTING CENTRE COVER PANEL



37. Compile the components as shown
- Centre cover panel
 - 2 x M6 cage nuts
 - 2 x M6 x 25 socket head cap screw stainless steel
 - 2 x M6 x 25 bolts
 - 4 x 6mm flat washers
 - 2 x black nylon packers
 - 2 x 8mm thick gold zinc spacers
 - 4 x 6mm spring washers

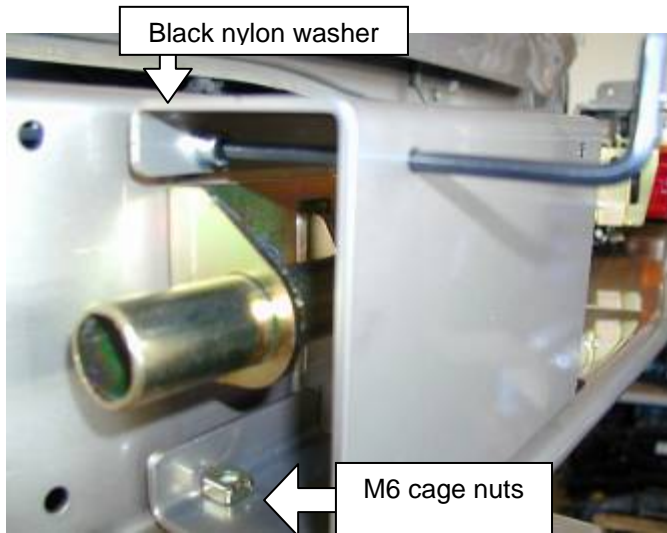

38. Place M6 cage nuts into lower section of centre cover panel.
39. Fit two **M6 x 25 stainless steel socket head cap screws**, flat washers and spring washers through top flange inside cover panel as shown.
40. Place black nylon spacers on screws on outside of centre cover panel flange and attach to captive nuts in rear bar. (Finger tighten only.)



41. Place 8mm spacer between underside of centre cover panel and rear bar.

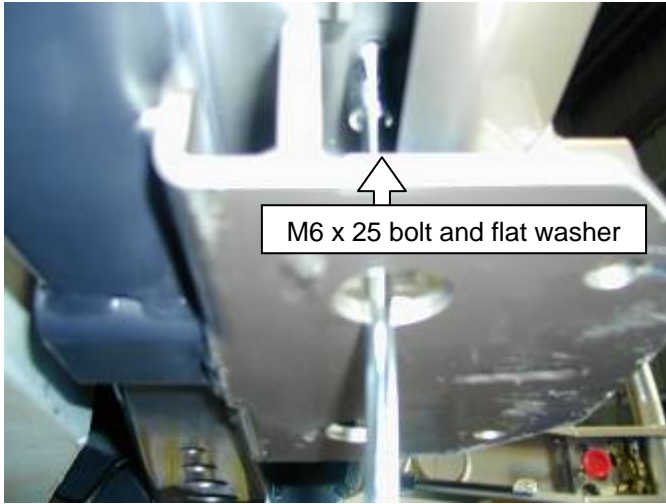

42. From underneath rear bar pass two **M6 x 25 bolts**, flat washers and spring washers through the aligned parts and finger tighten.

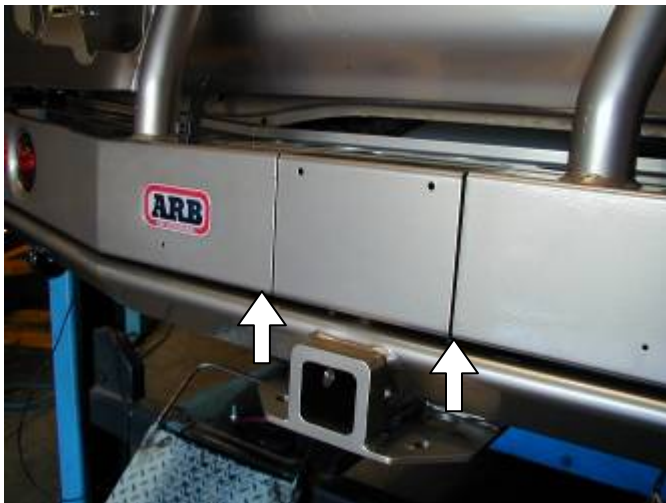

43. Align faces of centre cover panel with wheel carrier, jerry can carrier or cover panel and tighten securely.

FITTING END SURROUNDS TO REAR BAR

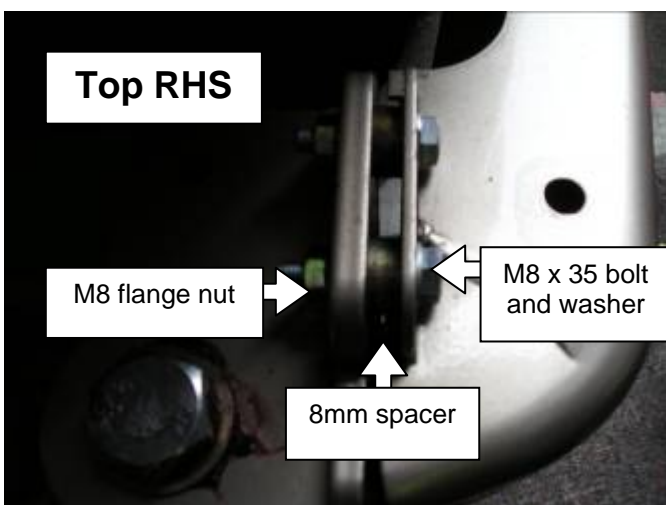

44. The surrounds are attached to rear bar using three **M8 x 35 bolts**, flat washers and flange nuts per side.

45. Place bolts and flat washers through the top two holes of the rear bar end plate as shown.

46. Fit 8mm spacer to bolts, then fit end surround and secure finger tight with M8 flange nuts.

47. Fit the lower bolt with washer, spacer and nut in the same sequence as the upper two.
(Finger tighten only)



48. Using **M8 x 20 bolts**, flat washers and flange nuts secure end surrounds to braces finger tight. (RHS shown.)

VIEWED FROM RHS OF VEHICLE.



49. Before tightening bolts fit urethane vertical trim between end plate and end surround.



50. Adjust trim to fit snugly around the rear bar and the end surround.



51. Align top face of end surround parallel with body of vehicle.

52. Starting in the top corner of the end surround and working backwards tighten all bolts.

A second person may be required to help keep the vertical trim fitting snugly and to ensure the end surround remains parallel to the body.

	<p>53. Fit reflector to end of buffer.</p> <p>54. Fit urethane buffer to top of end surround using M6 nyloc nuts and large black flat washers.</p> <p>When fitting washers to studs under end surround smear flat washers with grease to hold them in place as shown below.</p> <div style="display: flex; justify-content: space-around;">   </div>
---	---

FITTING TOP INFILL PLATE AND ALUMINIUM STEP PLATE

	<p>55. Using M6 button head cap screws fit top infill plate.</p>
	<p>56. To fit rubber sealing strip to underside of aluminium step plate, lay strip on the underside of step plate and place so over hang is even on both ends. Using scissors, cut darts up to the bulb end of the rubber strip, so the strip can follow the front profile of the aluminium step plate.</p>

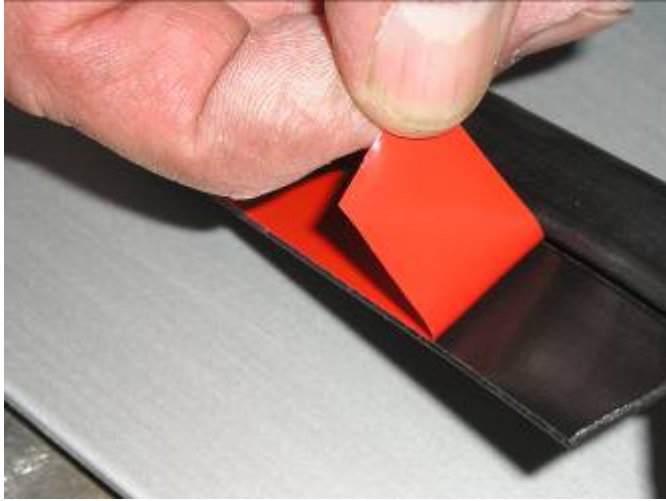

57. Carefully remove backing tape on the rubber strip and fit to step plate working from the centre outwards. Make sure rubber strip hugs the front edge of the aluminium step plate.

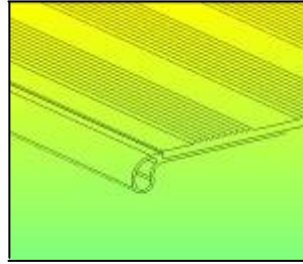

58. Using **M6 button head cap screws** fit aluminium step plate

FITTING TRAILER PLUG AND GOOSENECK

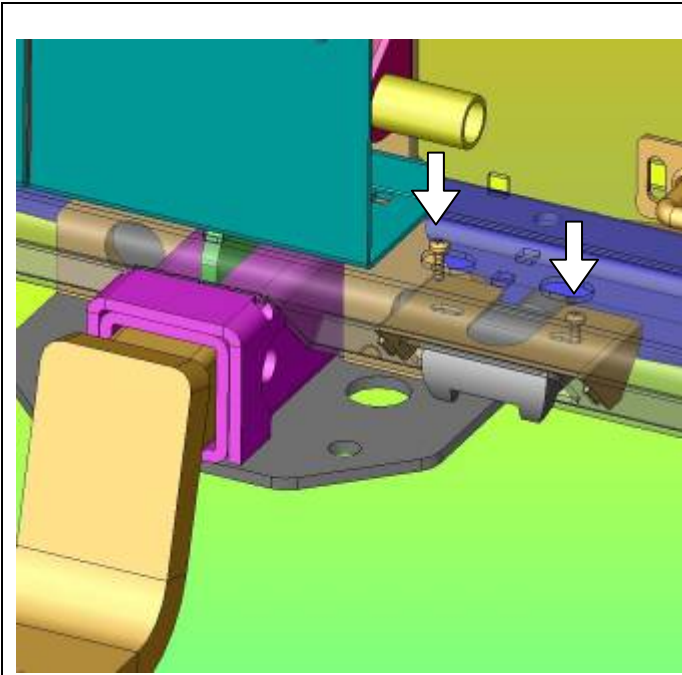

59. Fit trailer plug to recess using M5 pan head screws as shown by arrows.

For aesthetics and protection of the plug it is recommended that a flat type plug is fitted.

To fit alternate plugs an adaptor bracket (part number 5700090) is available. This is not supplied as standard with the rear bar kit.



60. Fit gooseneck with pull pin and spring clip as shown.

