



FITTING INSTRUCTIONS

PART NUMBER AND DESCRIPTION:

3614120 – REAR STEP TOW BAR (RSTB)

SUITED TO VEHICLE/S:

Toyota Hilux 2015 ON

WARNING

NOTE THE FOLLOWING:

- ◆ This product must be installed exactly as per these instructions using only the hardware supplied.
- ◆ In the event of damage to any tow bar component, contact your nearest authorised ARB stockist.
- ◆ Do not use this product for any vehicle make or model, other than those specified by ARB.
- ◆ Do not remove labels from this tow bar.
- ◆ This product or its fixing must not be modified in any way.
- ◆ The installation of this product may require the use of specialized tools and/or techniques
- ◆ It is recommended that this product is only installed by trained personnel.
- ◆ These instructions are correct as at the publication date. ARB Corporation Ltd. cannot be held responsible for the impact of any changes subsequently made by the vehicle manufacturer.
- ◆ During installation, it is the duty of the installer to check correct operation/clearances of all components.
- ◆ Work safely at all times.
- ◆ Unless otherwise instructed, tighten fasteners to specified torque.
- ◆ The eyelets on the rear bar have been designed and tested for connection of trailer safety chains. They are not to be used for recovery or direct towing.
- ◆ For recovery, fit a suitable and rated tow hitch to the central tow hitch receiver.
- ◆ Position high lift jack at lift locations beneath the middle of the wings and corner of the RSTB. Do not lift directly from the end of the wing.
- ◆ When using the tow hitch receiver, the centre panel should be in the raised position.

ARB 4x4 ACCESSORIES

Corporate Head Office

42-44 Garden St
Kilsyth, Victoria
AUSTRALIA 3137

Tel: +61 (3) 9761 6622
Fax: +61 (3) 9761 6807

Australian enquiries
North & South American enquiries
Other international enquiries

sales@arb.com.au
sales@arbusa.com
exports@arb.com.au

www.arb.com.au

GENERAL CARE AND MAINTENANCE

By choosing an ARB Bar, you have bought a product that is one of the most sought after 4WD products in the world. Your bar is a properly engineered, reliable, quality accessory that represents excellent value. To keep your bar in original condition it is important to care and maintain it following these recommendations:



- Prior to exposure to the weather your bar should be treated to a Canuba based polish on all exposed surfaces. It is recommended that this is performed on a six monthly basis or following exposure to salt, mud, sand or other contaminants.
- As part of any Pre Trip Preparation, or on an annual basis, it is recommended that a thorough visual inspection of the bar is carried out, making sure that all bolts and other components are torqued to the correct specification. Also check that all wiring sheaths, connectors, and fittings are free of damage. Replace any components as necessary. This service can be performed by your local authorized ARB Stockist.

FITTING REQUIREMENTS

REQUIRED TOOLS FOR FITMENT OF PRODUCT:

BASIC TOOL KIT	SIDE CUTTERS
INSULATION TAPE	70MM HOLE SAW BIT
DEUTSCH CRIMPING TOOL	WIRE STRIPPER
NEEDLE NOSE PLIERS	POWER DRILL
ALLEN KEY SET	SOCKET SET
FINE ROUND FILE	TAPE MEASURE
MASKING TAPE	RUST PREVENTATIVE PAINT

HAVE AVAILABLE THESE SAFETY ITEMS WHEN FITTING PRODUCT:

Protective eyewear		Hearing protection	
--------------------	---	--------------------	---

NOTE: 'WARNING' notes in the fitting procedure relate to OHS situations, where to avoid a potentially hazardous situation it is suggested that protective safety gear be worn or a safe work procedure be employed. If these notes and warnings are not heeded, injury may result.

FASTENER TORQUE SETTINGS:

SIZE	Torque Nm	Torque lbft
M6	9Nm	7lbft
M8	22Nm	16lbft
M10	44Nm	32lbft
M12x1.75	77Nm	57lbft
M12x1.25	95Nm	71lbft

RSTB PARTS LISTING

APPLICATION	PART NO.	QTY	DESCRIPTION
PREPARE REAR STEP TOW BAR (RSTB)	4654116	1	ASSY RSTB HILUX 150N WELDED
	6151715	18	NUT M6 CAGED 3.6-4.5MM 836-D
	6602011	2	CANOE CLIP
	4584295	4	WASHER FLAT M6 x 12 x 1.3 BLK ZN
	6523002	1	LIFT UP PANEL
	5670026	2	SPRING EXT 11.25 OD x 43
	6151256	2	SCREW BTN HD M6 x 16 SS
	6151549	2	NUT NYLOC M6 x 1.0 GR8.8 BTZP480
RSTB TO VEHICLE	3789470	1	TEMPLATE HILUX 2015 NUMBER PLATE
	6523079R	1	PANEL BEAVER HILUX 2015 RH
	6523079L	1	PANEL BEAVER HILUX 2015 LH
	3194833	1	PLATE 10MM SPANNER
	6821189	4	PLASTIC SNAP-IN LARGE GROMMET
	6151135	4	NUT M12 x 1.25 ZP
	6151384	4	SCREW ST PHDCOL PH 5.2 x 16 TBZP480
	5848302	4	PACKER RB NYLON
	6151213	8	BOLT M6 x 1.0 x 20 Gd8.8 BZ
	4584295	18	WASHER FLAT M6 x 12 x 1.3 BLK ZN
	6151459	4	SCREW BTN HD M6 x 16 BZ
	6151549	8	NUT NYLOC M6 x 1.0 GR8.8 BTZP480
	4581287	2	WASHER SPRING M6 x 2.5 x 1.6 BLK ZN
	3759696	1	BRKT NUMBER PLATE FRAME
	3759695R	1	BRKT NUMBER PLATE MOUNT RH
	3759695L	1	BRKT NUMBER PLATE MOUNT LH
	6151096	14	BOLT HXHD M12 X 1.25 X 40 CL8.8 ZP
	4581049	18	WASHER FLAT, M12 METRIC
	4581050	14	WASHER SPRING M12 METRIC
	3194821	2	PLATE ASSY CHASSIS
	3194820	2	PLATE INFILL
	3194819	1	STEP PLATE EXTRUSION
6151256	10	SCREW BTN HD M6 x 16 SS	
PREPARE RSTB/VEHICLE FOR PANELS	3199943	1	CAGE PLATE JK JEEP (225mm)
	6151303	1	NUT CAGED M8 1.8-3.2
	3759746	1	BRKT WING MOUNT
	3759774	1	ASSY SENSOR GUARD MOUNT
	3759776	1	BRKT WING MOUNT LH
	6151022	12	BOLT M8 x 1.25 x 25 Gd 8.8 ZP
	4581046	10	WASHER SPRING M8 METRIC
	4581063	8	WASHER FLAT, M8 x 25 x 3 GOLD ZN
	4581020	1	WASHER FLAT M8 x 30 x 3 TZP480
	6151083	1	BOLT M8 X 1.25 X35 ZP
	4581044	3	WASHER FLAT, M8 ZP
3789454	1	TEMPLATE HILUX 2015 WING H/CUT	

RSTB PARTS LISTING

APPLICATION	PART NO.	QTY	DESCRIPTION
PANELS TO RSTB/VEHICLE	6151022	12	BOLT M8 x 1.25 x 25 Gd 8.8 BP
	4581063	20	WASHER FLAT M8 x 25 x 3 ZN
	6151032	10	NUT NYLOC M8 x 1.25
	4581046	4	WASHER SPRING M8 x 3/32 x 3/32
	6151256	8	SCREW BTN HD M6 x 16 SS
	6151549	2	NUT NYLOC M6 x 1.0 GR8.8 BTZP480
	4581304	8	WASHER FLAT M6 S/S
	4584295	2	WASHER FLAT M6 x 12 x 1.3 BLK ZN
	6523071	1	PANEL DIFFUSER RH NO SENSOR
	3194723	2	PLATE NUT ASSEMBLY
	3194724	2	PLATE NUT ASSEMBLY
	6523072	1	PANEL DIFFUSER LH NO SENSOR
	4581082	4	WASHER M6 X 20 BZ
	3131538R	1	WING ASSY HILUX - NO SENSOR RH
	3131538L	1	WING ASSY HILUX - NO SENSOR LH
TOW TONGUE	4761170	1	TOW TONGUE 45 DEG
	55010	1	TOW BAR PULL PIN
	55020	1	SPRING CLIP
	180302	10	CABLE TIE 200MM

TRAILER WIRING

The following trailer wiring solutions can be purchased from ARB. Purchase the main wiring harness with ECU (Part no. 3600010) in conjunction with the appropriate socket and tail listed below. Alternatively, this product is compatible with the factory trailer wiring solution.

To install this loom, a crimping tool suitable for crimping contact typesize16Deutsch pins is required. Suitable crimping tools can be purchased from auto electrical wholesalers as shown.



APPLICATION	PART NO.	QTY	DESCRIPTION
TRAILER WIRING	3600010	1	RSTB WIRING INCLUDING ECU
	3600020	1	RSTB SOCKET & TAIL 7 PIN FLAT
	3600030	1	RSTB SOCKET & TAIL 12 PIN FLAT
	3600040	1	RSTB SOCKET & TAIL 7 PIN ROUND LRG
	3600050	1	RSTB SOCKET & TAIL 7 PIN ROUND SML

OPTIONAL ACCESSORIES

The following ARB accessories can be fitted to this product:

APPLICATION	PART NO.	QTY	DESCRIPTION
OPTIONAL ACCESSORIES	171403	1	ARB AIR LINE FITTING
	10600030	1	ARB TRAILER CAMERA KIT
	58X22/A	1	RECOVERY HITCH AND SHACKLE
	6594050	1	50 AMP ANDERSON PLUG

			
AIR LINE FITTING	TRAILER CAMERA KIT	RECOVERY HITCH	ANDERSON PLUG

GENUINE ACCESSORIES REMOVAL

Removal of rear bumper bar:



1. Disassemble the bumper bar from the chassis bar by removing 2 M12 bolts from each side as shown.



2. If fitted, remove the 2 M8 bolts from the headlight levelling sensor guard and then remove the M8 bolt from the cable clamp



3. Remove the spare wheel from beneath the tub using the wheel nut wrench and jack handle pieces supplied with the vehicle. Insert as shown through the access slot above the number plate position and rotate counter-clockwise to release the wheel.

VEHICLE/RSTB WIRING

A trailer wiring solution that incorporates a smart ECU is available for this vehicle. To fit this solution, the rear vehicle wiring harness must be cut and high quality, waterproof Deutsch connectors installed to provide signal pickup points for the ECU.

To install this loom, a suitable crimp tool is required. Refer to Page 4 for more details about the crimp tool.

Follow the steps below to install the trailer wiring solution:

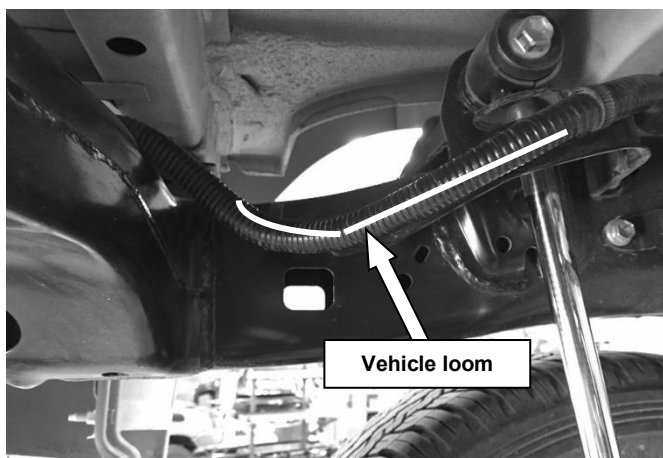

4. Locate the vehicle loom on the left hand chassis rail near rear shock absorber mount as shown. Remove tape if present and expose 200mm of the following coloured wires from the split corrugated tubing:

Yellow	(LH Indicator)
Red	(Reverse)
Light Blue	(RH Indicator)
Blue	(Brakes)
Green	(Clearance)

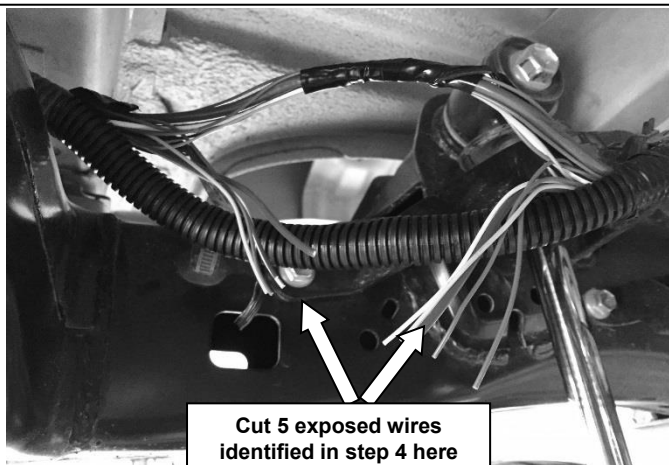

Note: Prior to cutting the exposed wires, please ensure and re-check (with a test light or multimeter) that the correct wires have been identified as per their corresponding function, as there are multiple wires of the same colour in the vehicle loom.

5. Cut a 90mm section from the centre of the 5 exposed wires. This will leave ~55mm of wire before they re-enter the corrugated tubing at each end.

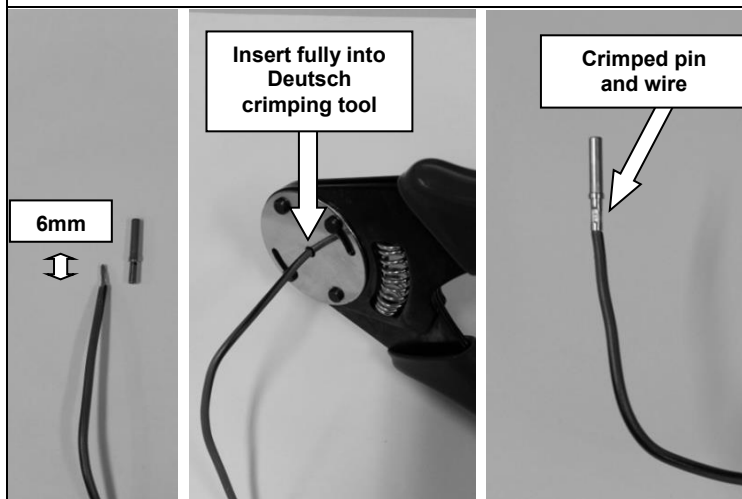

6. Remove 6mm of the plastic insulation coating from the end of each newly cut wire.

7. Insert each wire into the shorter end of a metal Deutsch pin.

8. Insert the longer end of the metal Deutsch pin into a crimping tool and crimp the wire and pin together as shown.

VEHICLE/RSTB WIRING

White blank pin
in position 6

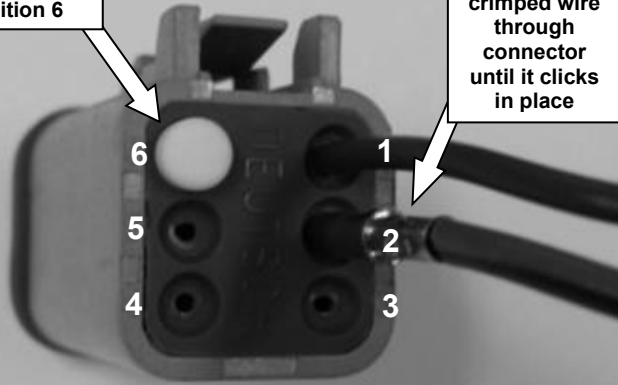

9. Insert one set of wires into a male 6-pin connector from the back in the following order:

Pin position	Wire colour
1	Yellow
2	Red
3	Light Blue
4	Blue
5	Green

Note: Pin positions are shown on the back of the connector.

Plastic cover on
the front side of
connector



10. Insert the white blank pin into position 6 as shown in the previous step.
11. Insert the plastic cover to the front of the connector as shown.
12. Repeat steps 17-19 for the other connector.

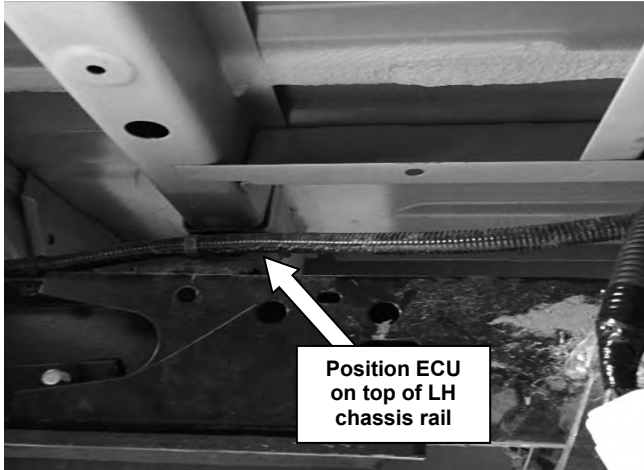

13. Position ECU on top of LH chassis rail behind cross member as shown. Secure using the ECU mounting holes and chassis rail holes with 2 cable ties.
14. Connect the ECU unit to the RSTB wiring harness using the large 12 pin connector.

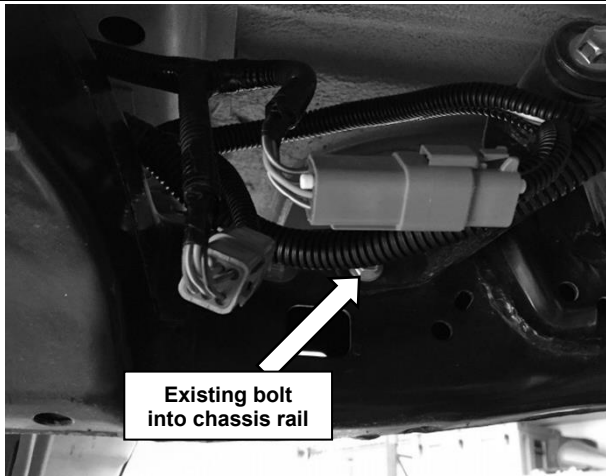

15. Connect the ground wire of the RSTB harness to the bolt on the LH chassis rail near the rear shock absorber mount.

VEHICLE/RSTB WIRING

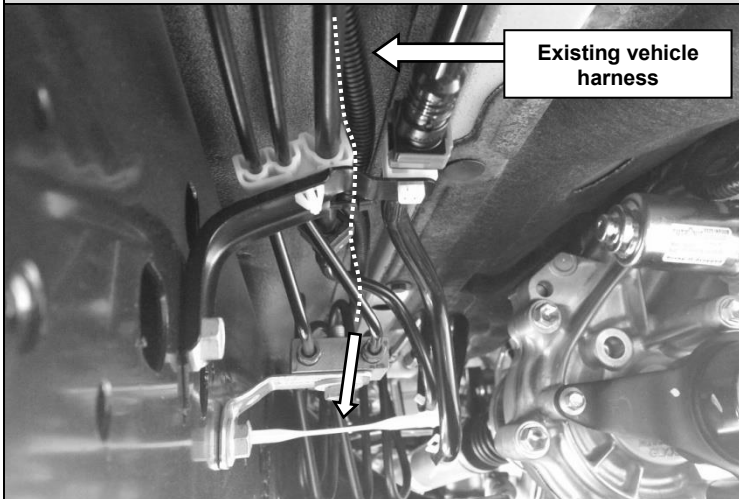

16. Route the positive supply wire to the front of the vehicle following the existing vehicle harness along the left chassis rail.

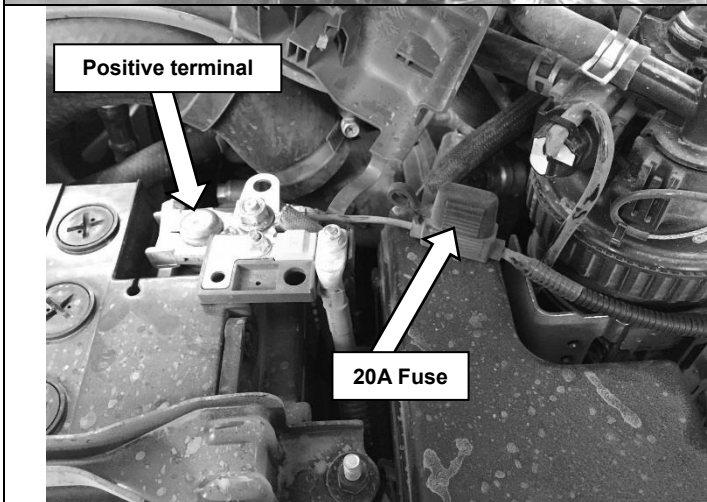

17. Continue routing the positive supply wire through the engine bay to the battery.
18. Connect the positive supply wire to the positive terminal of the battery using the existing bolt as shown.

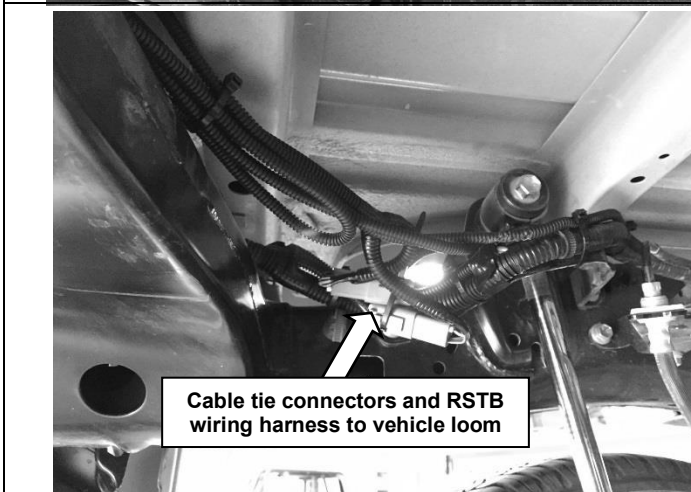

19. Connect the RSTB wiring harness to the 2 male 6-pin connectors.
- Note: The RSTB wiring harness is not polarity sensitive in this region so the male 6-pin connectors can be connected to either female connector.**
20. Ensure vehicle tail lights function correctly.
21. Fasten the connectors to the vehicle loom using the cable ties provided.



22. Re-wrap the un-cut wires with the existing split corrugated tubing and new tape.
23. Tidy and fasten all wiring using the cable ties provided.
- Warning: Make sure all wires are securely fastened away from any hot, sharp or moving surfaces. Do not fasten wiring harness to fuel or brake lines.**
24. Ensure vehicle tail lights function correctly.

PREPARE REAR STEP TOW BAR (RSTB)



25. Place the RSTB on a flat surface that will not damage its coating as shown.

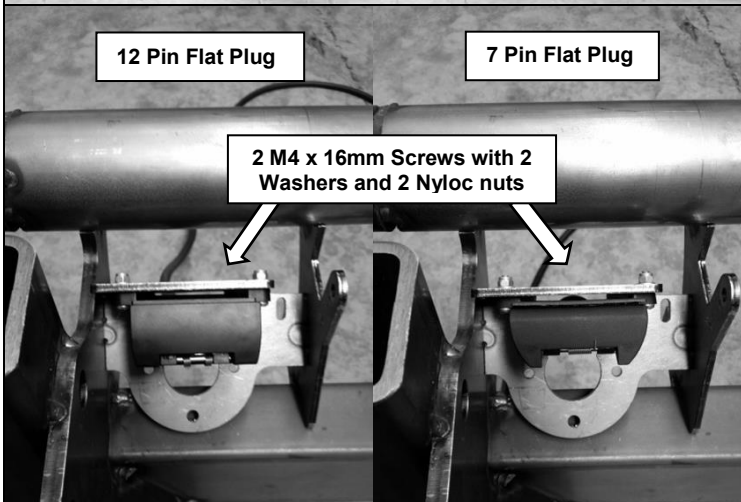

For fitment of flat trailer plugs:

26. Using the appropriate mounting holes as shown and fasteners supplied with the trailer plug, attach the trailer plug to the trailer plug bracket on the RSTB.

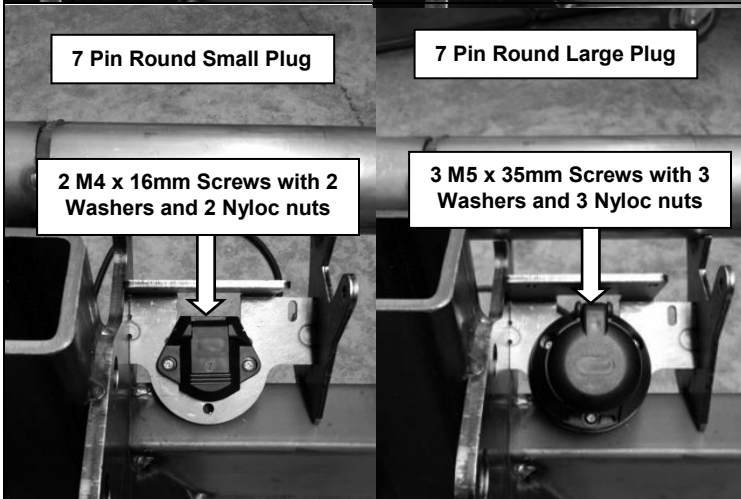

For fitment of round trailer plugs:

27. Using the appropriate mounting holes as shown and fasteners supplied with the trailer plug, attach the trailer plug to the trailer plug bracket on the RSTB.

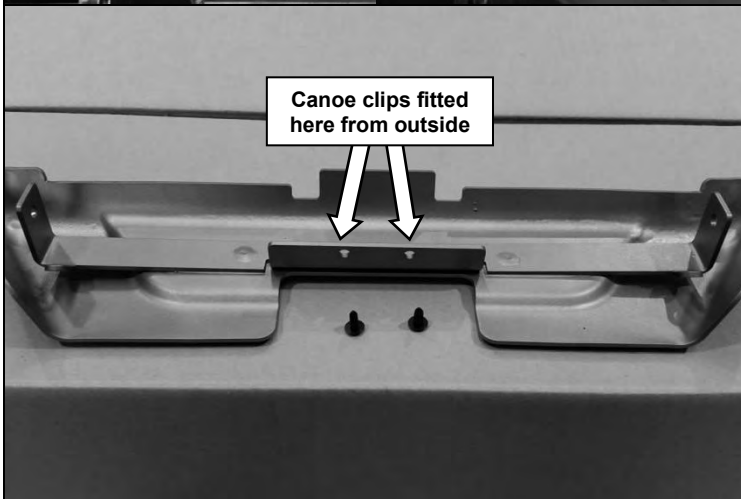

28. Fit 2 plastic canoe clips to the lift up panel using the holes as shown.

PREPARE REAR STEP TOW BAR (RSTB)

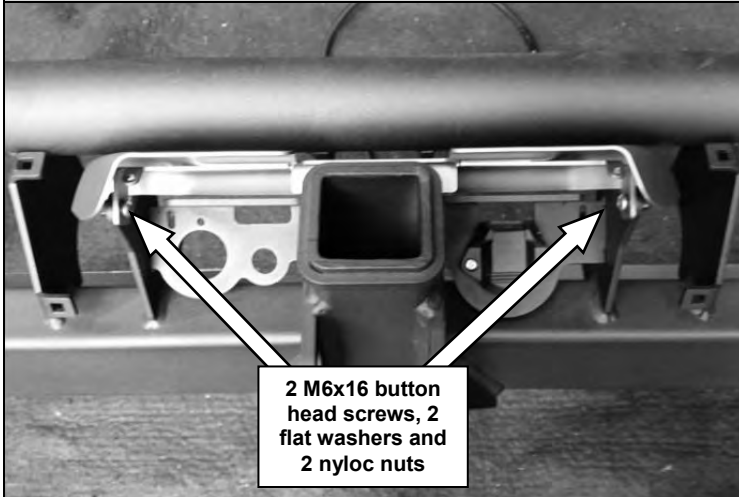

29. Attach the lift up panel to the pivot plates on the RSTB using 2 M6x16 button head screws, 4 M6 flat washers and 2 M6 nyloc nuts.
30. Tighten the screws enough to ensure the lift up panel is centralised with minimal sideways movement, but still able to lift up and down freely.

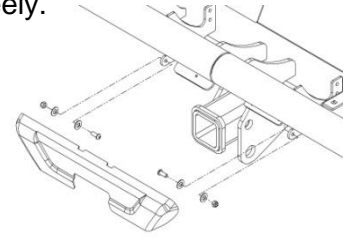

31. Rotate the RSTB 90° so it is now resting flat on the ground as shown.

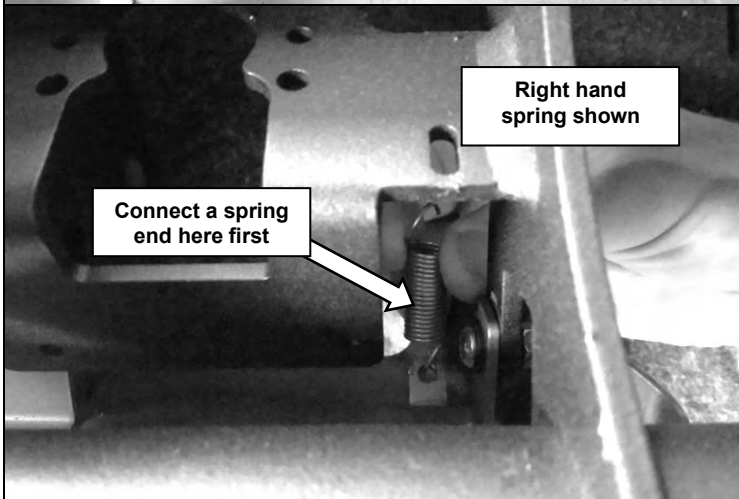

32. Connect 2 springs between the RSTB and lift up panel. From above, first connect one end of each spring to the lift up panel as shown.

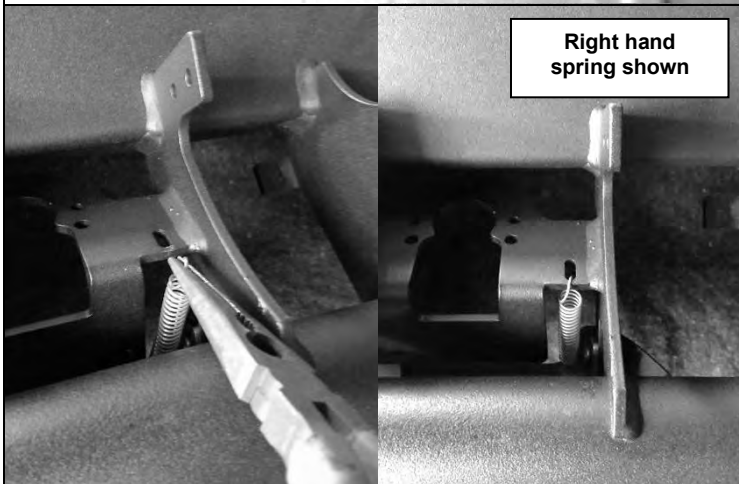
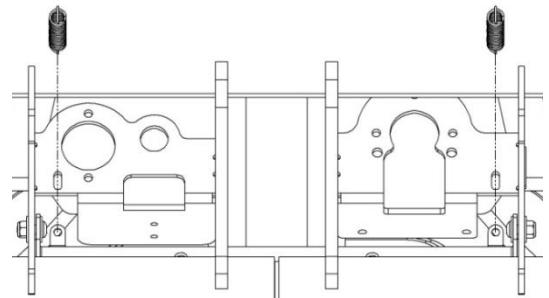

33. Using pliers, stretch the free end of each spring up to the bracket on the RSTB as shown.



Warning: Safety glasses should be worn for this operation as the spring may slip off the pliers if not clamped tightly

PREPARE REAR STEP TOW BAR (RSTB)

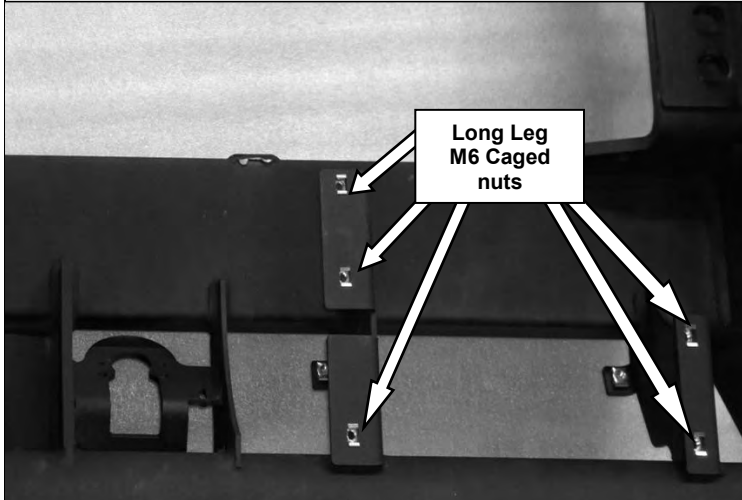

34. Fit 10 long-leg M6 caged nuts to the RSTB. Fit 5 caged nuts to the right side as shown and 5 cage nuts to the left hand side

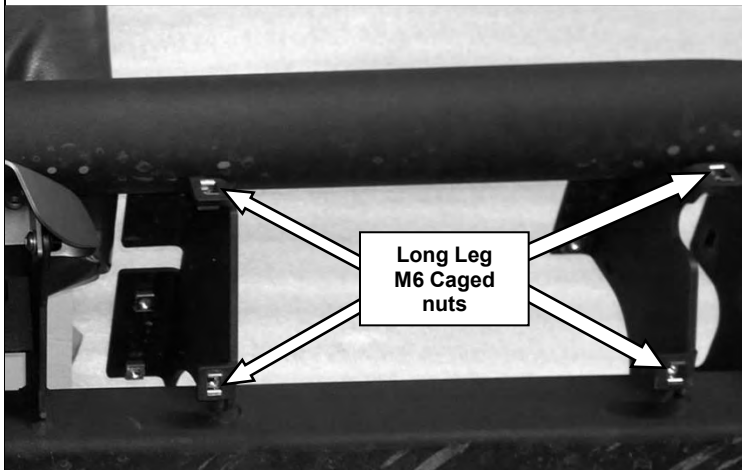

35. Rotate and support the RSTB and fit 8 long-leg M6 caged nuts. Fit 4 caged nuts to the right side as shown and 4 cage nuts to the left hand side

RSTB TO VEHICLE

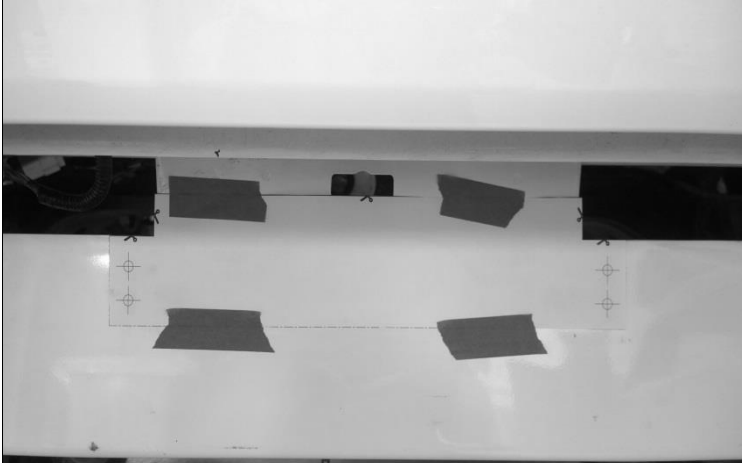

36. Place the number plate drilling template on the rear panel of the tub as shown. When aligned use masking tape to hold in place
37. Center punch the 4 holes, remove template and drill to $\text{\O}6.5\text{mm}$ and de-bur each holes to remove all sharp edges.



38. Temporarily fasten beaver panel to rear of tub and align upper edge of beaver panel so it is parallel with tailgate lower edge.



39. When the alignment is achieved drill $\text{\O}6.5\text{mm}$ hole through tub face. Remove temporary fasteners holding beaver panel in place. De-bur the hole to remove all sharp edges.
40. Treat all raw edges with a rust preventative paint.

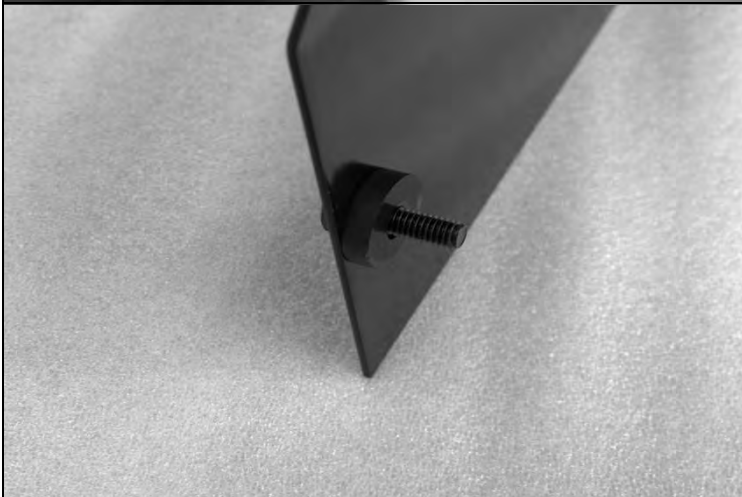

41. Insert M6X20 bolt and washer through beaver panel and position spacer as shown

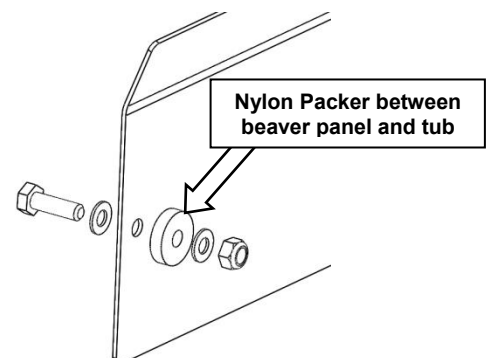

RSTB TO VEHICLE



42. Attach beaver to rear of tub as shown using single M6 fastener

 M6 X 1.0 - 9 Nm.

43. Repeat steps 38 to 42 for left hand side.

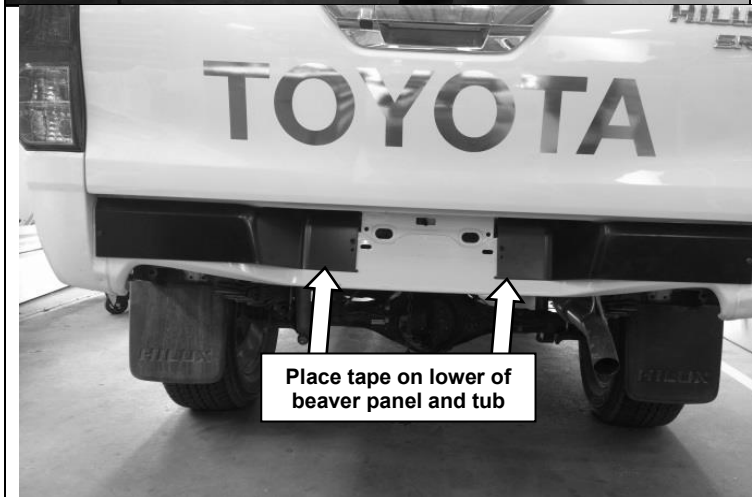

44. Place tape in center section to temporarily hold beaver panel in place

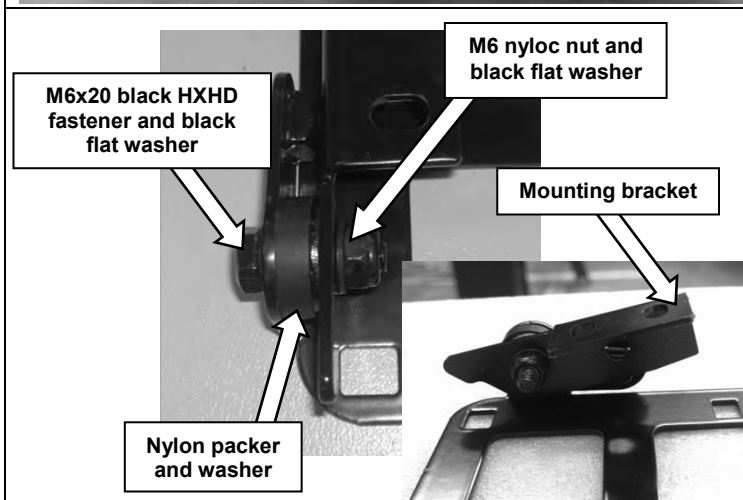

45. Assemble license plate bracket as shown taking note of mounting bracket orientation. Repeat step for opposite side of license plate bracket.

46. Tighten the screws enough so the brackets can be rotated by hand but not freely by themselves.

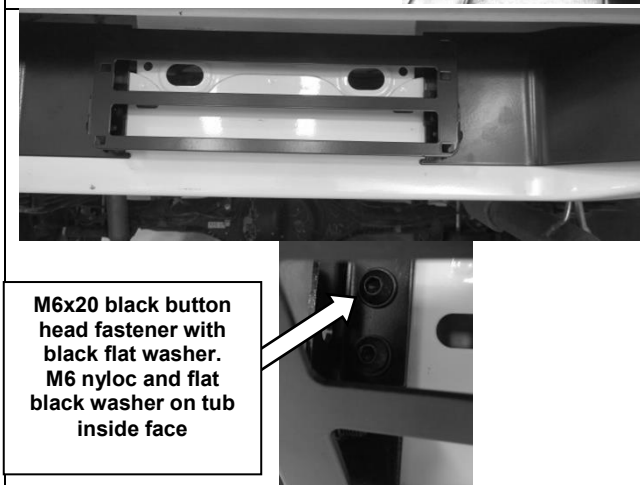

47. Fix the license plate assembly to the beaver panel using 4 M6x1.0x16 button head screws, 8 M6 flat washers (black), and 4 M6 nyloc nuts as shown.

48. Tighten all screws to the specified torque.

 M6 X 1.0 - 9 Nm.

RSTB TO VEHICLE

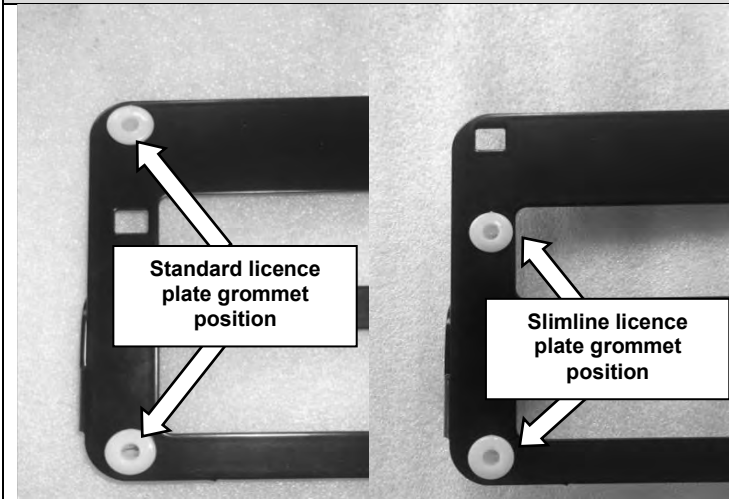

49. Insert 4 plastic grommets into number plate frame to suit licence plate size



50. Using 4 screws supplied fasten licence plate to frame.
51. Screw in partially 2 M6 X 20 black hexhead fastener along with black M6 washer and spring washer into upper hole of licence plate frame (both sides).

Note :These fasteners are used to stop licence plate frame from rotating to an open position when the vehicle is in motion.



52. With the assistance of other people or a lifting device, lift the RSTB up beneath the chassis rails, aligning the threaded holes in the side of the chassis with those in the vertical surfaces of the RSTB.

Note: Take care to ensure the trailer plug wiring is not damaged during this step.

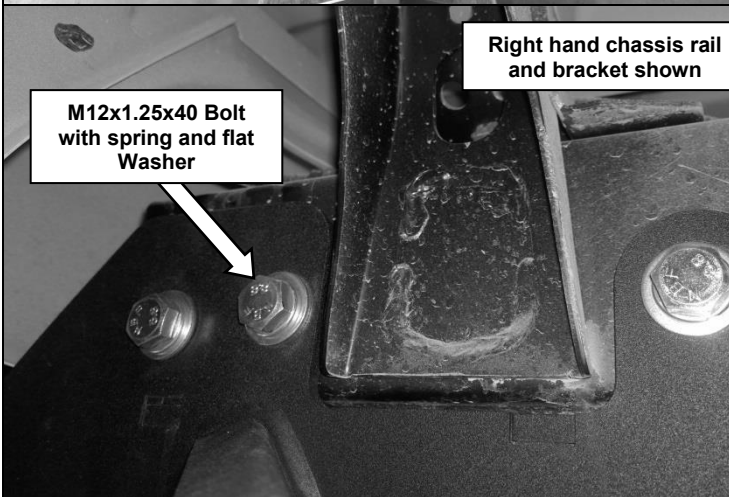

53. Fix the vertical plates of the RSTB to the threaded holes in each chassis rail using 3 M12x1.25x40 (fine pitch) hex head bolts, 3 M12 spring washers and 3 M12 flat washers per chassis rail. Leave finger tight at this stage.

RSTB TO VEHICLE



54. Fix the front two horizontal mount points using M12x1.25x40 (fine pitch) hex head bolts, flat /spring washer and nut.
55. Insert chassis plate in chassis and fasten the remaining horizontal mount points using 2 M12x1.25x40 (fine pitch) hex head bolts, 2 M12 spring washers and 2 M12 flat washers
56. Check RSTB spacing to vehicle and tighten all fasteners to the specified torque.



M12 X 1.25 - **95 Nm.**



57. Route the trailer plug loom through the RSTB and attach to the appropriate connector on the RSTB wiring harness or vehicle loom as shown.
58. Ensure all trailer tail lights function normally.

Note: Test that the trailer park, brake and reverse lights function normally. Also test the left and right indicators along with the hazard setting.

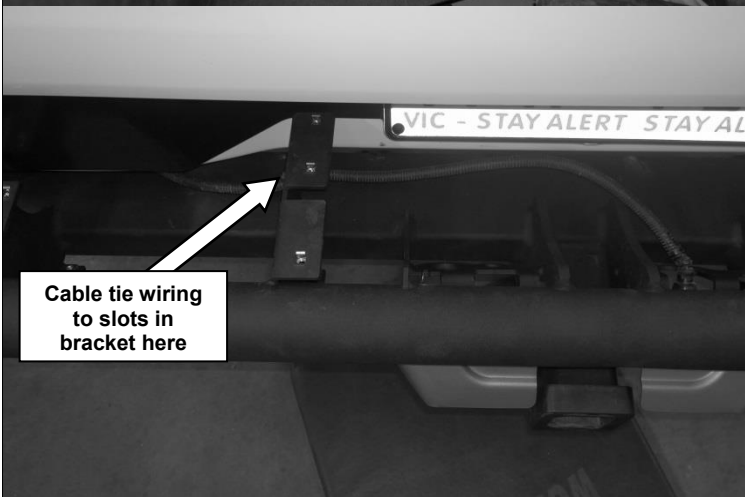

59. Tidy and fasten all wiring using cable ties and the slots in the RSTB brackets, as well as existing fastening locations.

Warning: Make sure all wires are securely fastened away from any hot, sharp or moving surfaces. Do not fasten wiring harness to fuel or brake lines.

60. Ensure trailer tail lights function normally as per step 58.

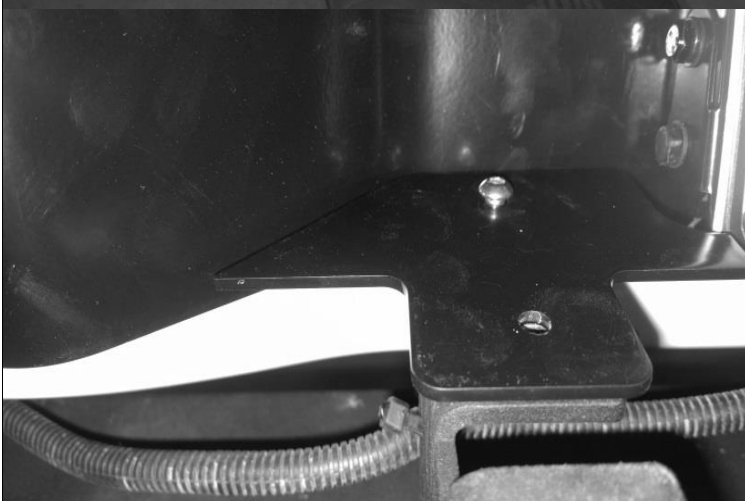

61. Fit infill plate on either side of licence plate as shown using 1 M6 X 16 Stainless button head screw per infill plate. Only hand tighten fastener at this stage ensuring second hole is aligned.

RSTB TO VEHICLE



62. Attach the step plate extrusion to the RSTB using 8 M6x1.0x16 button head screws. Proceed to tighten fasteners installed in step 61

NOTE : Do not install washers under the 8 M6 button head screws that are fixing the step plate extrusion to the RSTB

PREPARE RSTB/VEHICLE FOR PANELS

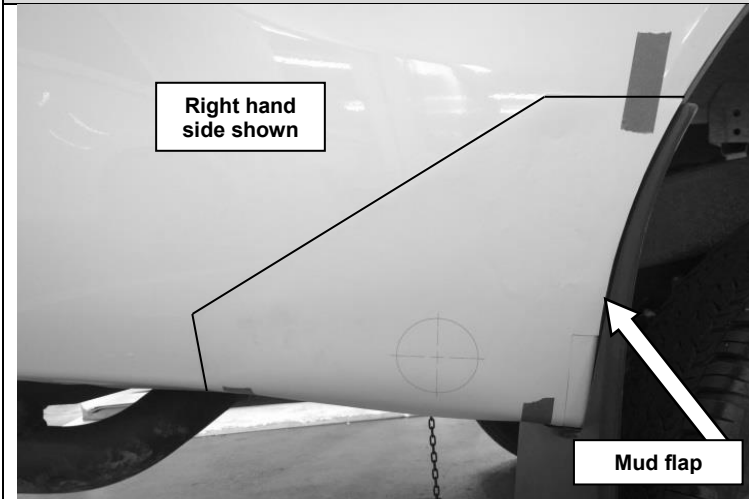

63. Place the cutting template on the right hand rear side panel of the tub aligning it with the wheel arch edge of tub and bottom edge of the tub. Use masking tape to hold in place.

64. Mark the centre of the cutting hole on the rear side panel and then remove the template.



65. Using a $\text{\O}70\text{mm}$ hole saw, drill through the rear side panel using the mark from the previous step as the centre point of the hole.



66. Repeat steps 63 to 65 for the left hand rear side panel using the opposite side of the template.



67. De-bur each hole to remove sharp edges.

68. Treat raw edges with a rust preventative paint.

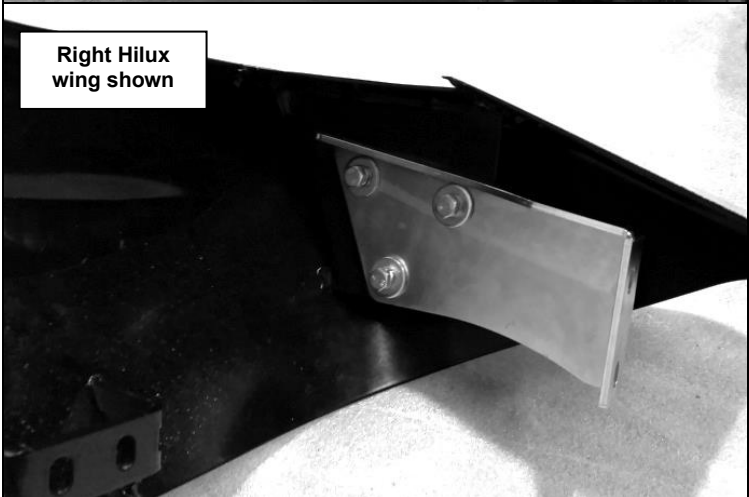

69. Fix a wing mount bracket to each Hilux wing using 3 M8x1.25x25 hex head bolts, 3 spring washers, 3 flat washers and a wing triple nut plate. Orientate each bracket as shown. Leave bolts finger tight at this stage

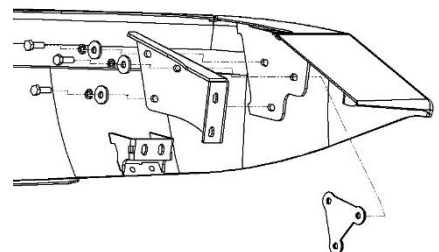

PREPARE RSTB/VEHICLE FOR PANELS

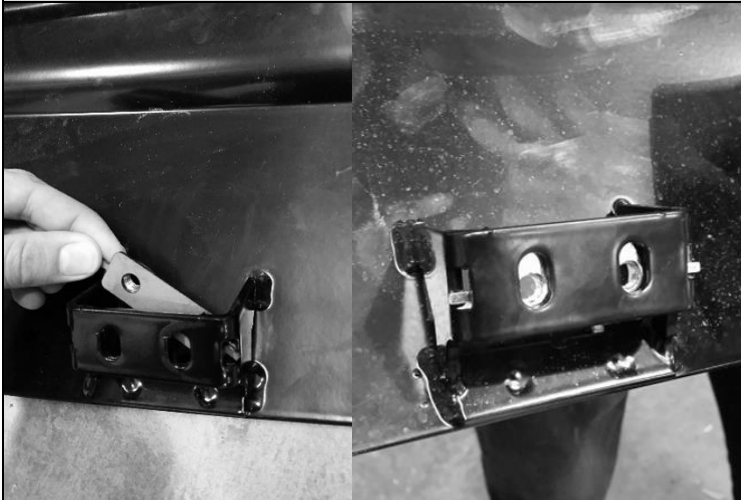

70. Place a wing double nut plate inside the middle bracket of each Hilux wing as shown.

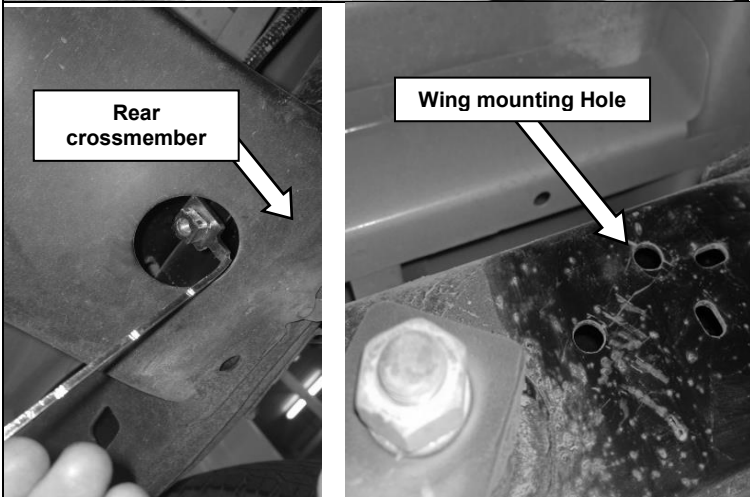

71. Assemble M8 cage nut and plate, bend to slightly less than 90deg as shown and insert into chassis through hole in cross member.
72. Check to ensure cage nut plate is accessible to insert M8 X 1.25 fastener through hole in chassis rail as shown.



73. Position the right hand wing mountstrut under the tub and fix to the threaded holes in the chassis rails using 1 M8x1.25x35 hex head bolt, 1 M8 spring washer and 1 M8X30X3 flat washer for each bracket. Leave finger tight at this stage.

Note: Struts should be positioned with leading edge towards wheel arch as shown.

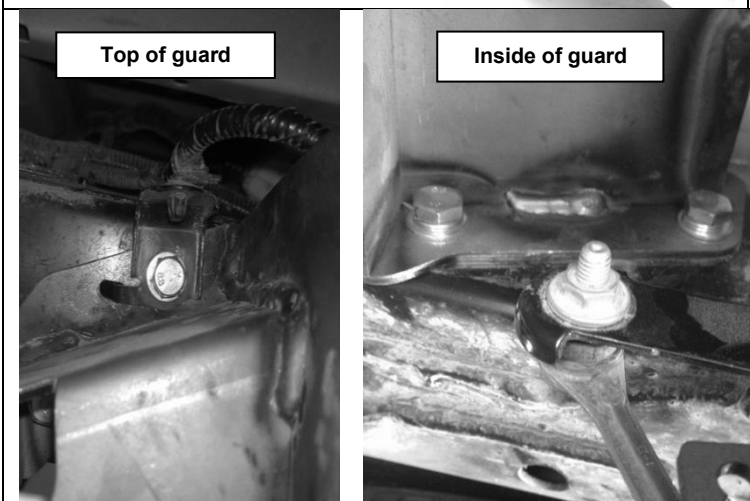
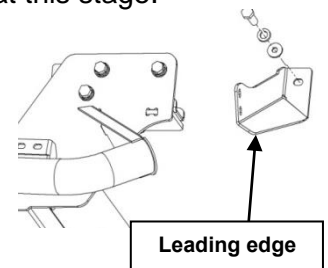

74. On the left hand side of vehicle fit sensor guard mount using 3 M8X1.25X35 hex head bolts, 3 M8 spring washers and 3 M8 standard flat washers. Ensure cable retaining mount is fitted and anti-rotation is located in slot of bracket.

PREPARE RSTB/VEHICLE FOR PANELS



75. Fit left hand wing mount as shown using 2 M8x1.25x25 hex head bolts, 4 M8 flat washers and 2 M8 nyloc nuts. Do not fully tighten at this stage.

PANELS TO RSTB/VEHICLE



76. With the assistance of other people or a lifting device, position the Hilux wings next to the rear side vehicle panels. Take care not to damage the vehicle when positioning the Hilux wings.

Apply masking tape to tub to eliminate any damage to paintwork when positioning wing

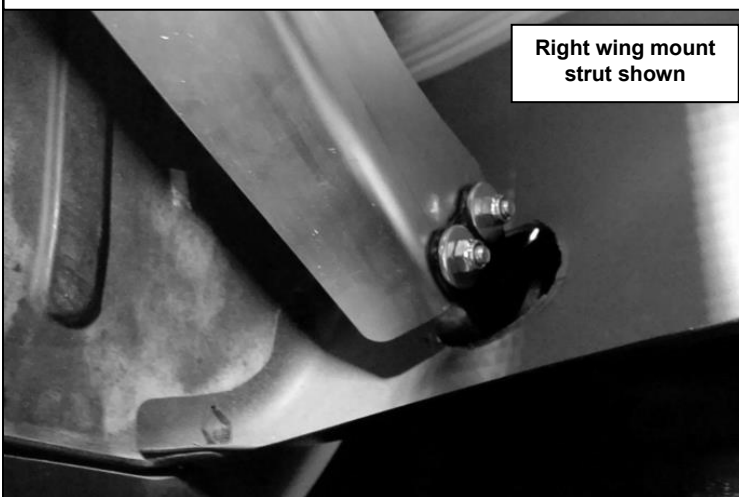

77. Pass the front bracket of each Hilux wing through the $\text{\O}70\text{mm}$ hole in the tub and fasten to the wing mount strut using 2 M8x1.25x25hex head bolts, 4 M8 flat washers and 2 M8 nyloc nuts. Do not fully tighten at this stage.

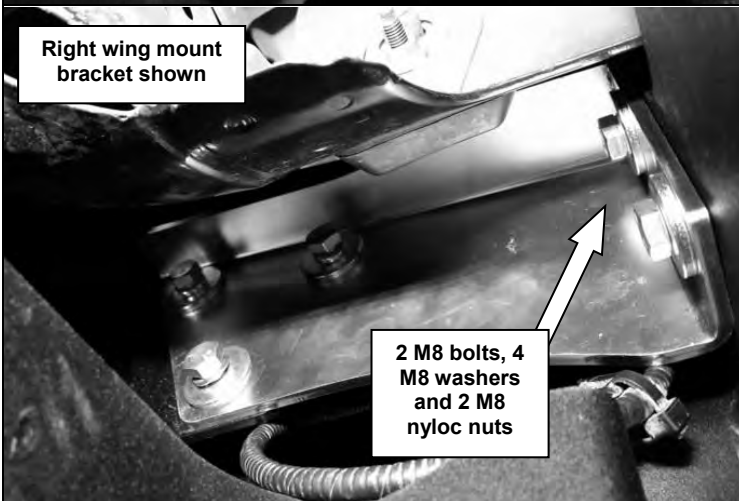
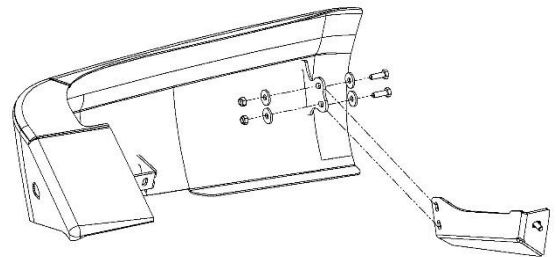

78. Fix the wing mount bracket of each Hilux wing to the RSTB using 2 M8x1.25x25hex head bolts, 4 M8 flat washers and 2 M8 nyloc nuts. Do not fully tighten at this stage.



79. Fix the middle bracket of each Hilux wing to the RSTB tube using 2 M8x1.25x25hex head bolts, 2 M8 spring washers, 2 M8 flat washers and the wing double nut plate already fitted. Leave bolts finger tight at this stage.

PANELS TO RSTB/VEHICLE

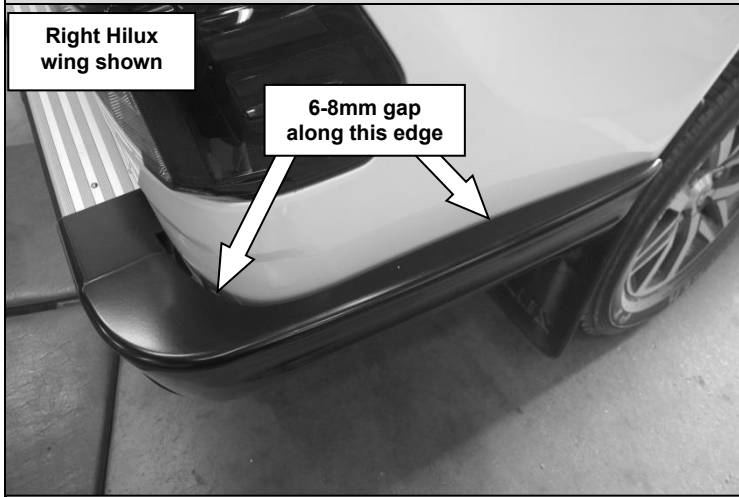

80. Position each Hilux wing so there is an even 6-8mm gap to the side vehicle panels.

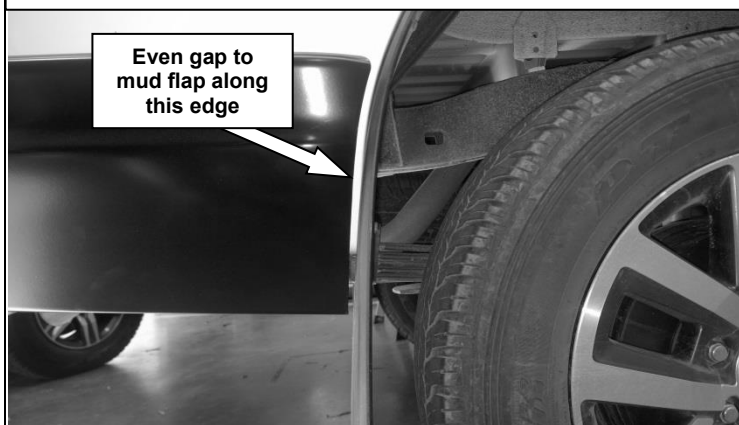

81. Position each Hilux wing so they there is an even gap to the mud flap as shown.

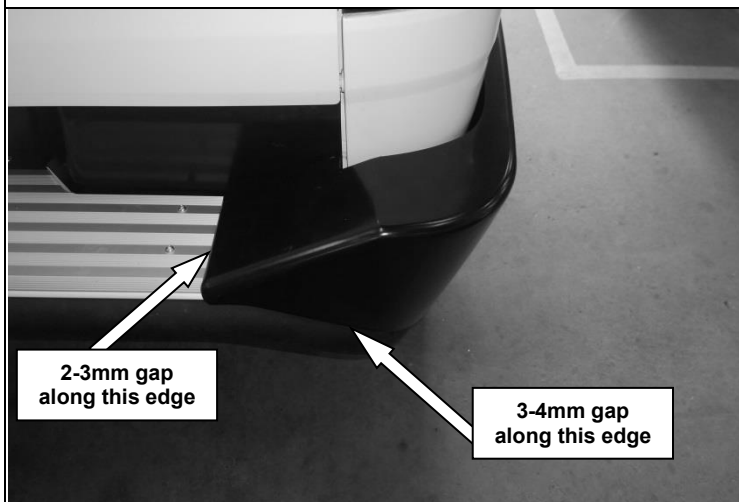

82. Position each Hilux wing so they sit evenly on the step plate extrusion and there is an even gap to the tube as shown.



83. Tighten all the M8 bolts that retain each Hilux wing to the specified torque.

 M8 X 1.25 - 22 Nm.

Note: Check that all clearances are maintained as the fasteners are tightened.

PANELS TO RSTB/VEHICLE

Right diffuser panel shown



84. Position the diffuser panels on either side of the lift up panel as shown.

Right diffuser panel shown



Outside face- M6X20 Hex head bolt and M6x19 black washer.
Inside face - M6 X12 black washer and M6 nyloc nut

85. Attach the diffuser panels to the RSTB using 8 M6x16 button head screws and M6 stainless flat washers. For the outer most screw on each panel, retain using 2 M6X20 hex head bolts, M6x19 black washer and M6x12 black washer and M6 nyloc nut as shown.

Note M6X19 black washer is to be placed on outside of diffuser panel

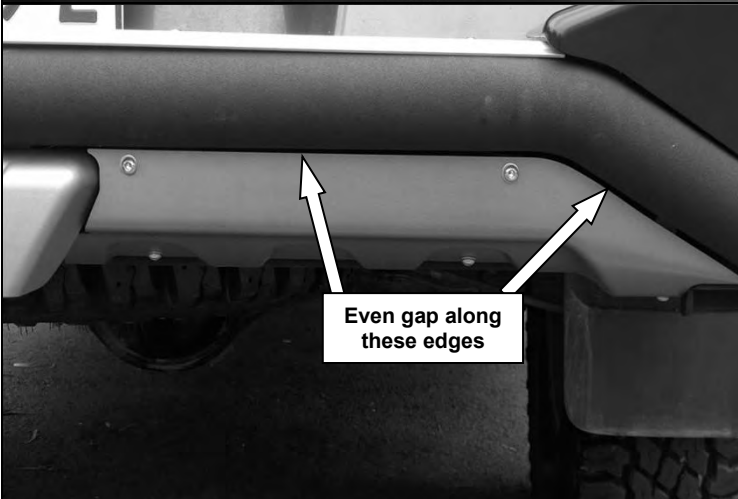

Even gap along these edges

86. Position each diffuser panel so there is an even gap between the panel and the RSTB tube. Tighten fasteners to the specified torque.



M6 X 1 -9 Nm.



87. Using 10mm spanner provided release licence plate retaining bolt on both sides sufficiently to allow licence plate to pivot down

PANELS TO RSTB/VEHICLE



88. Reattach the spare wheel beneath the vehicle. Return licence plate to upright position and tighten up licence plate bolts that were previously loosened in step 87



89. Store tow tongue, pull pin and R-clip in a safe and secure location when not in use.

FITTED PRODUCT



FITTED PRODUCT



TRAILER CAMERA PLUG, ANDERSON PLUG AND AIR-LINE FITTING



TRAILER PLUG

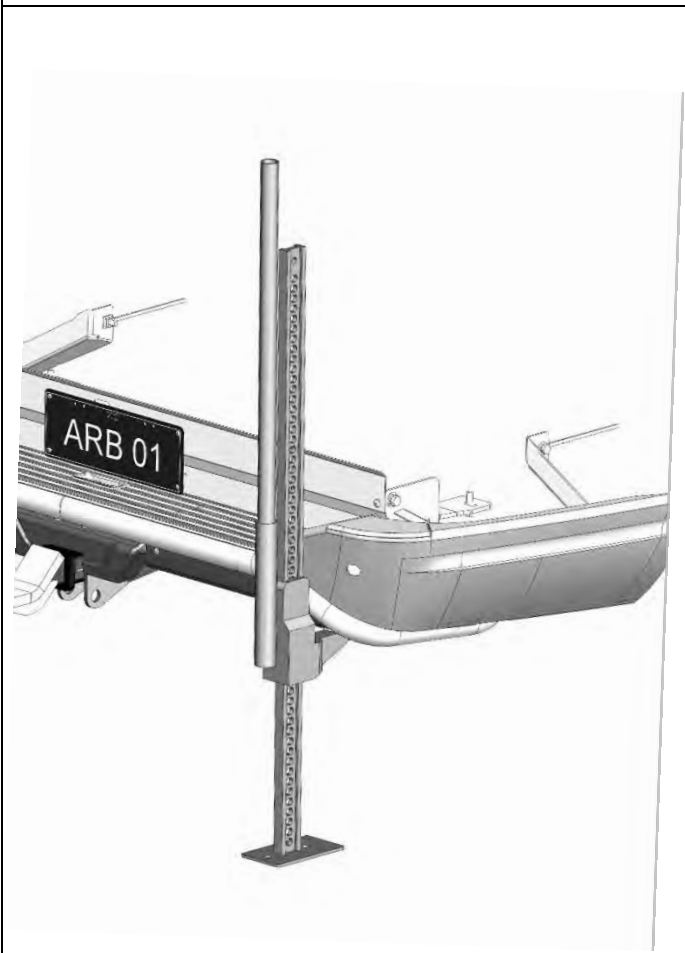

HIGH LIFT JACK LOCATION - CORNER OF RSTB

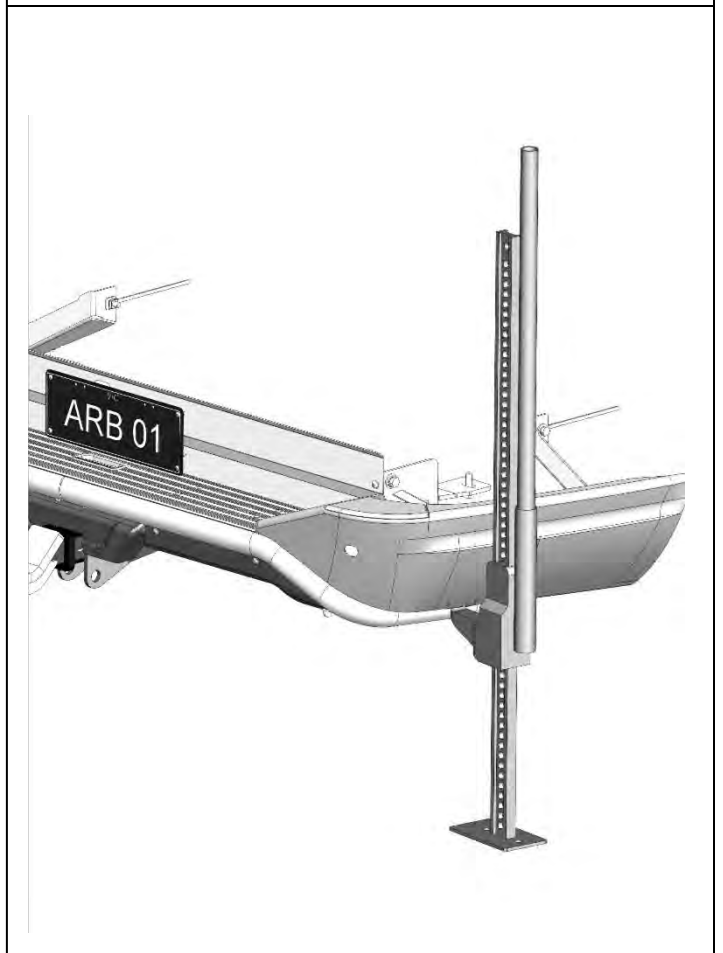

HIGH LIFT JACK LOCATION - SIDE OF WING/ABOVE TUBE

